

CLS FUSION

devices and luminaires



General information

With the publication of this catalogue, all previous versions lose their validity. During the period of validity of this catalogue, we reserve the right to make technical and formal changes to our products in order to improve them or to take account of changes in legal regulations. We are pleased to provide current data on request.

All LED luminaires are supplied incl. LED illuminant.

Industrial property rights exist for a large part of the products.

Current product information can be found on our homepage at www.inotec-licht.de

INOTEC Sicherheitstechnik GmbH

Innovative Emergency Lighting Technology



INOTEC Sicherheitstechnik GmbH is an innovative mid-sized company based in Ense-Höingen, Westphalia, with its own development, design, production and national and international sales.

A competent team with flexible and committed employees provides reliable support in all questions concerning products, planning, service and regulations.

Since its foundation in 1995, INOTEC Sicherheitstechnik GmbH has developed into a globally active company with over 310 employees. Further jobs have been created with the numerous partners within Europe and Middle East. The production, storage and administration facilities in Germany have grown to around 14,000m².

Today, INOTEC Sicherheitstechnik GmbH is one of the leading manufacturers in emergency and safety lighting. Modern, innovative and high-quality products "Made in Germany" set new standards worldwide, e.g. CLS 24 decentralised emergency lighting systems, central battery systems with JOKER technology and the dynamic escape route guidance D.E.R. system.



Contents

Advantages of decentralised systems



FUSION – more than just a concept

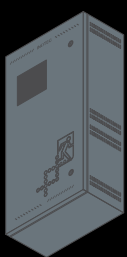

CLF FUSION
48Ah Power



CLF FUSION
24Ah Power

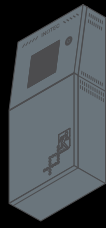

CLF FUSION
24Ah



CLF FUSION
12Ah



CLF FUSION
7Ah

CLF FUSION devices



INOView



- Regulation and standards
 - Special colours
 - INOTEC LED technology
-



Luminaires

- Contacts
- Luminaire categories



Decentralised system or central battery system?

In 2006 INOTEC Sicherheitstechnik GmbH introduced a new emergency lighting system: type CLS 24. As a decentralised system it is positioned between central battery, group battery- and self-contained battery system. It became the pioneer for a new generation of emergency lighting.

Compared to conventional system concepts such as central battery systems, the decentralized CLS systems are convincing with a significantly increased protection goal while maintaining the same comfort. Thus, in the event of failure of a decentralised system, only the luminaires within the supplied area are affected. With a central battery system, emergency lighting in the entire building would break down in the worst case.

The safety and emergency exit sign luminaires within the corresponding fire compartment are supplied by a stand-alone CLS system with its own battery. Compared to a central battery system supplying several fire compartments the complex and cost-intensive E30 cabling can be omitted. Additionally, a higher protection goal is achieved.

The decentralised emergency lighting system CLS FUSION is not only used in small projects with one fire compartment of 1600m², but also in bigger projects with several fire compartments. Especially in storage and production buildings the protection goal is exceeded by the decentralised arrangement. The integrated monitoring of systems and luminaires as well as the redundancy by several decentralised systems increases the safety in such buildings.



Conventional central battery system vs. decentralised system

Conventional central battery system

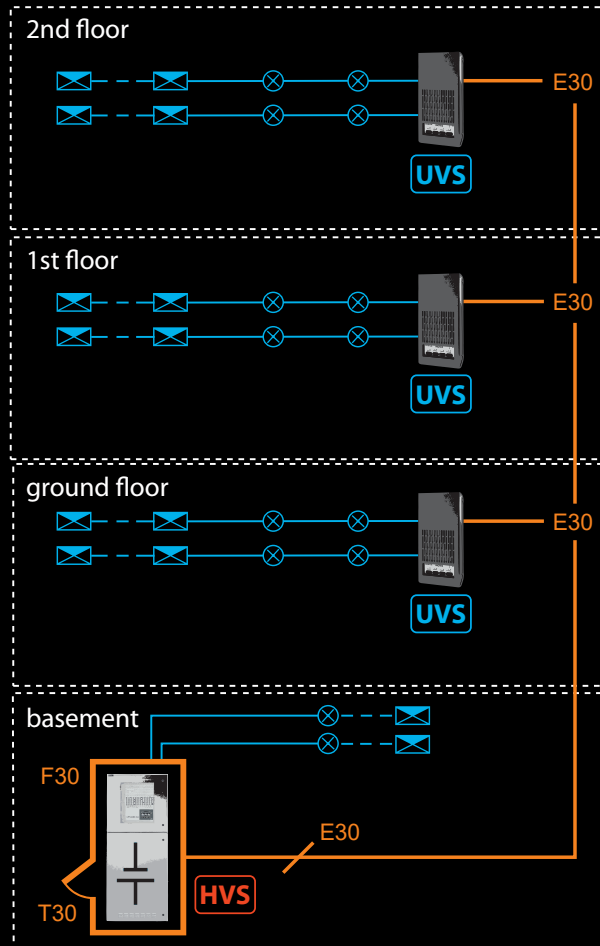

Failure HVS

Breakdown of the entire safety lighting

Failure cabling between HVS* and UVS*

Failure of all downstream UVS and safety lighting

Failure system

Breakdown of the entire safety lighting

Output voltage

230V AC or 216V DC with luminaires in protection class I or II. Thereby increased danger for constructor, user and service staff.

*HVS = Main distribution safety lighting, *UVS = Sub-distribution safety lighting,
*UVA = Sub-distribution general lighting

Decentralised system

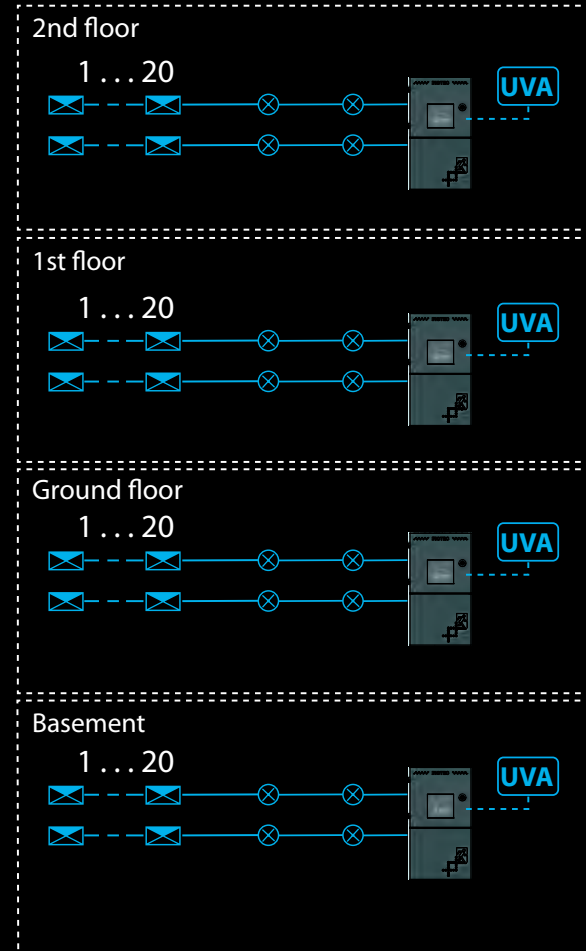

No HVS required due to decentralised installation

No cabling required due to decentralised installation

Failure of safety lighting only in the affected area

24V safety extra low voltage (SELV) with luminaires in protection class III. Therefore no danger for constructor, user and service staff.



Decentralised system or self-contained?

Self-contained

Due to the substitute power supply (battery) in every safety and emergency exit sign luminaire, the self-contained luminaire offers the best possible safety level. At first sight there is barely anything, which can be argued against the usage of the self-contained luminaires. Especially because the standards for the usage of self-contained luminaires have opened up.

However, when planning and installing the emergency and safety lighting with self-contained systems, many points have to be considered in order to achieve the required protection goal.

Decentralised systems

The decentralised CLS FUSION systems of INOTEC with their various power range are the best alternative to the self-contained technology, while still having the advantages of the central battery technology. The maintenance of decentralised systems is significantly easier than for self-contained luminaires. Another advantage is the much easier connection compared to self-contained luminaires.



Self-contained technology vs. decentralised systems

Self-contained technology

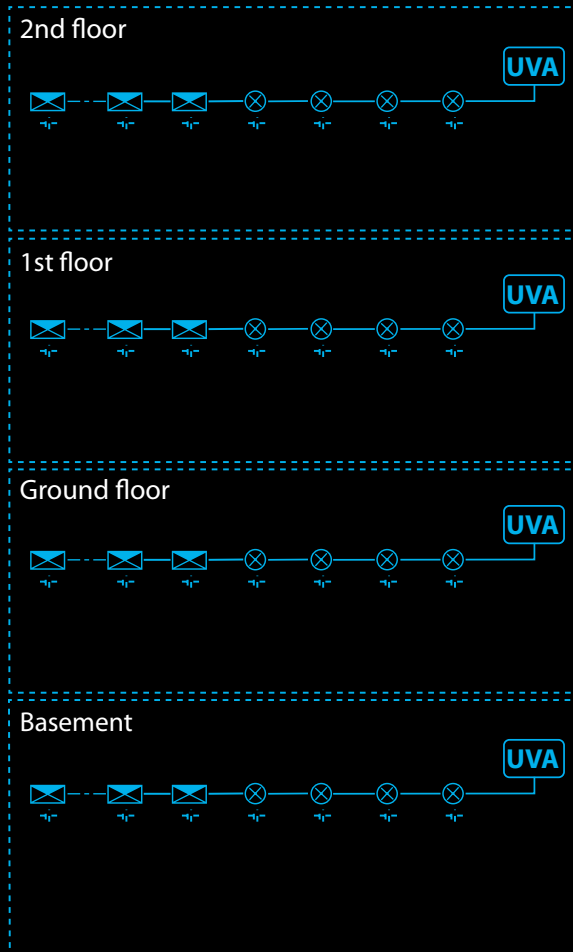

Decentralised system

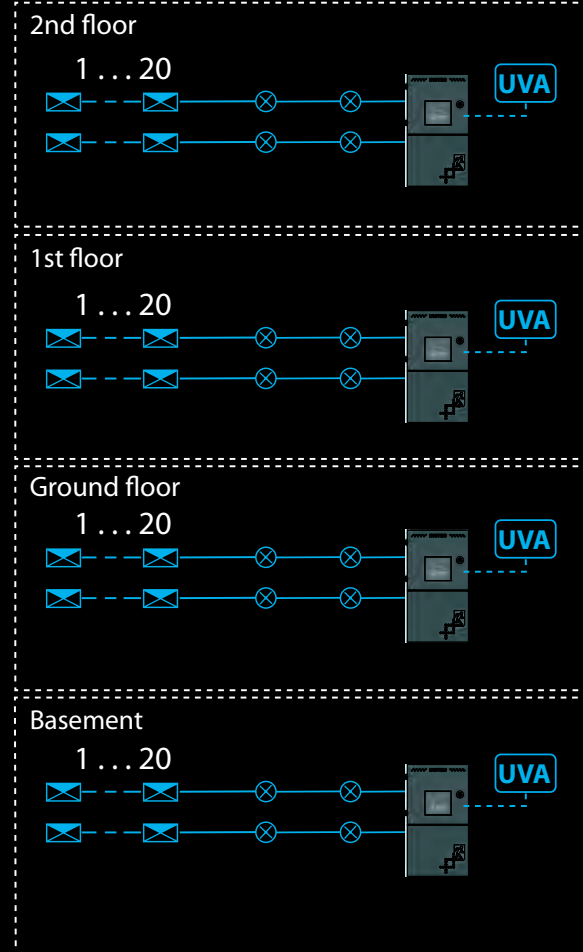

Central monitoring

Additional BUS line required

Battery change

Exchange at every luminaire

Charging voltage

Consider correct cabling at every luminaire

Number of luminaires

Reduced luminous flux in battery mode, therefore more safety luminaires required.

Monitoring and communication via supply line

Central battery change at the device

Simple central connection at the device

100% luminous flux also in battery mode results in the use of less safety luminaires.

*UVA = Sub-distribution general lighting

INOTEC CLS FUSION – more than just a concept

With the CLS FUSION we developed and optimised our decentralised systems in many ways.

FUSION - this term stands for merging multiple concepts. For this reason we decided to use this name for our new generation of devices. Because we merge - unite - innovative concepts and technologies in our new FUSION systems and thus create intelligent emergency lighting. This simplifies the use of decentralised emergency lighting systems for designers, installers and operators.



FUSION

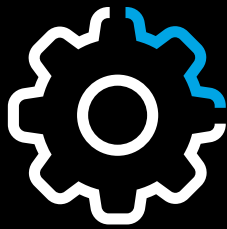

Functionality

Intelligent circuits extend the previous mixed operation mode by further possibilities within the same circuit.

With up to 8 circuits within a CLS FUSION, more power-optimised luminaires can be connected. External BUS components significantly extend the functionality of the CLS FUSION.



Safety

The individual LED monitoring increases the safety of the emergency- and safety lighting with LED technology compared to normal market standards. Due to the integrated Battery-Control-System the requirements of the draft standards are already considered now.



Ease of use

A modern, graphical touch display simplifies the usage of the CLS FUSION. Standard interfaces such as the USB interface allow information to be read out and the device to be programmed.

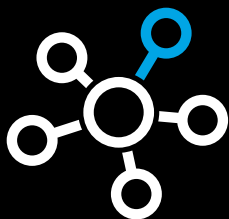

Connectivity

Different monitoring systems can be used such as INOView, INOWeb or the connection to a building management systems to supervise the status of your decentralised emergency lighting systems at a central point.

Functionality

Your JOKER for the future

1998 the INOTEC Sicherheitstechnik GmbH was the first company to introduce a mixed mode of maintained and non-maintained lighting in one circuit under the brand name "JOKER".

Since its launch in 2006, INOTEC CLS systems support the JOKER operation of safety and emergency exit sign luminaires in the same circuit. The CLS extended the JOKER functionality by the possibility to switch individual luminaires within a circuit via switch inputs.

With CLS FUSION, it is now possible to integrate dynamic emer-

gency exit sign luminaires into the circuit. The control is done without an additional BUS line. Thereby the design and installation of an dynamic escape route guidance system is simplified and installation costs are reduced.

If modifications occur during the design or operation, the static emergency exit sign luminaire can be exchanged by a dynamic luminaire without new wiring!

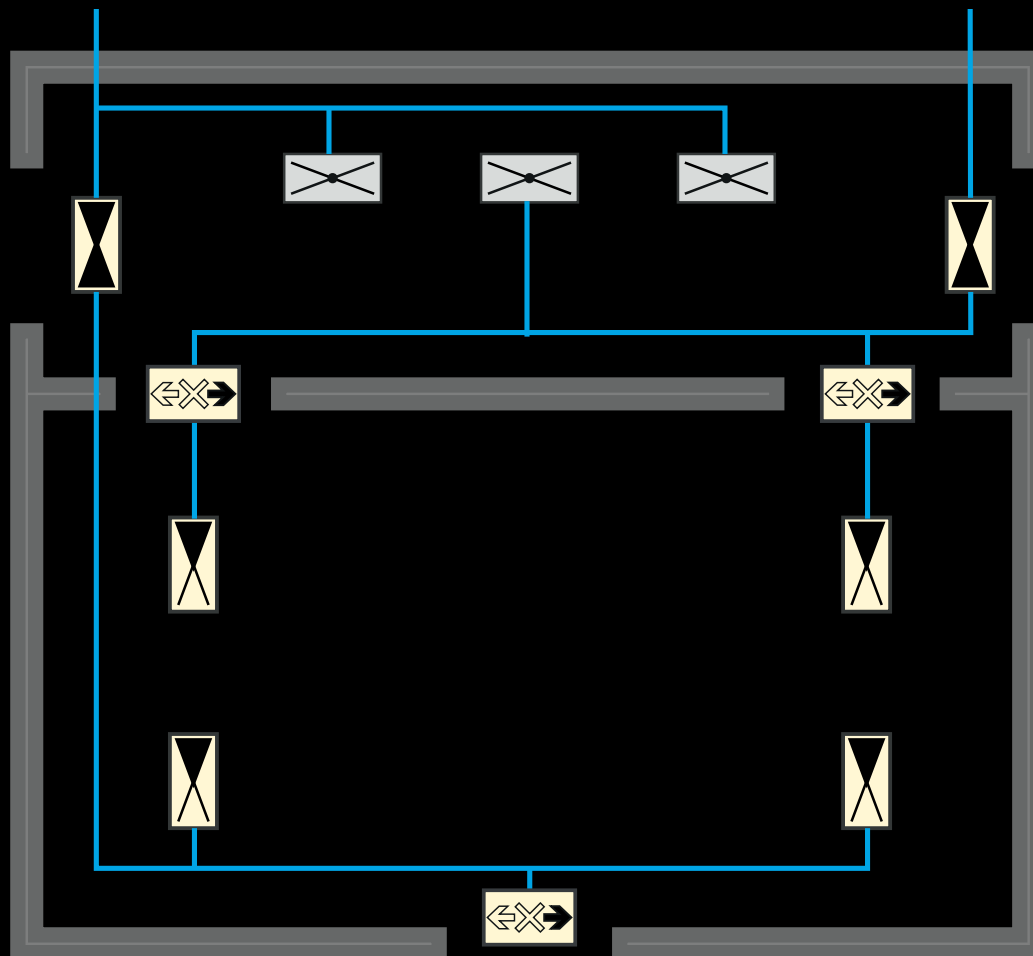

There is still the possibility for theatres, cinemas and auditories to dim individual luminaires in normal operation. In emergency mode the luminaires automatically switch to 100%.



5 switching modes for emergency exit sign and safety luminaires in the same circuit are available with CLS FUSION without additional data line.

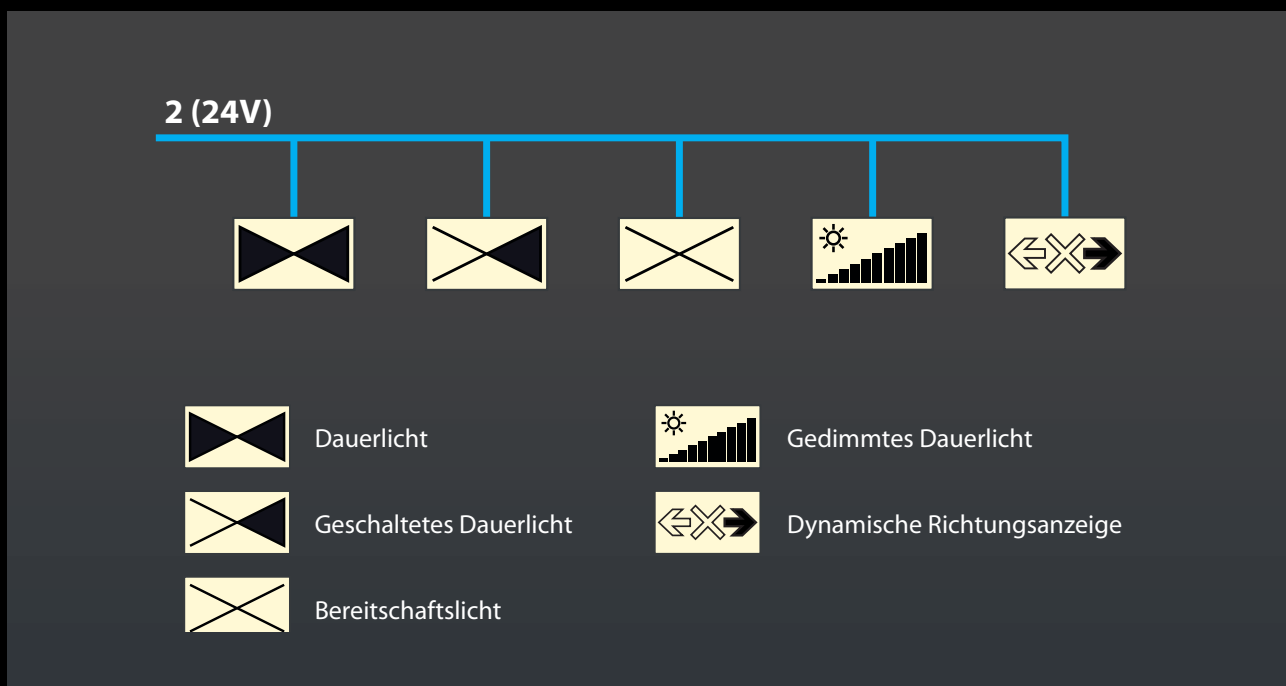

Functionality

Dynamic escape route guidance for a higher safety level

The standard emergency exit and safety lighting is designed to illuminate the escape routes and to guide the way via safety signs in case of a power failure. In case of a fire, escape routes may be blocked by smoke or fire itself. A static emergency exit lighting will still display it as a safe escape route!

Dynamic escape route systems take these situations into account and block escape routes while displaying safe alternatives. They support the self-rescue of people and contribute towards the safe evacuation of buildings.

With CLS FUSION dynamic emergency exit sign luminaires are now operated without additional BUS-line in the same circuit like the standard emergency exit and safety lighting.



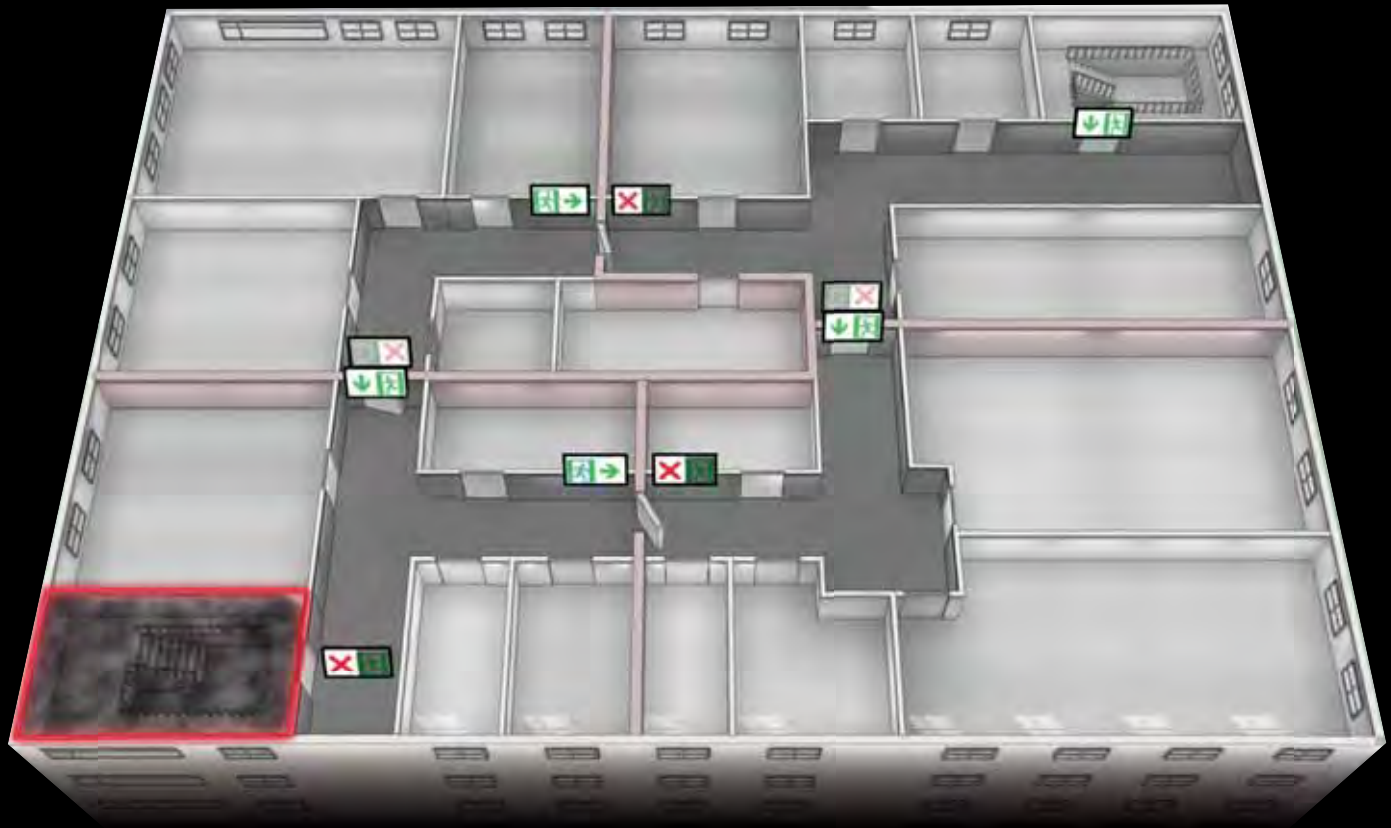

Dynamic escape route solutions are becoming more and more common in changing building uses or to compensate structural fire protection measures.

If the escape route cannot be used anymore or only partly, the static marking does not serve its purpose. For example when the emergency exits are closed during special events.

The CLS FUSION can operate dynamic emergency exit sign luminaires as well as the standard emergency exit lighting within the same circuit. Structural conditions like the way of usage of areas or buildings as well as normative and legal requirements can be easily followed with the CLS FUSION.

Up to 8 switch inputs can be allocated to each dynamic emergency exit sign luminaire at a CLS FUSION to trigger the luminaire depending on the situation.



Functionality

Flexible expansion

The CLS FUSION supports up to 8 circuits per device for more functionality of the emergency lighting system. The expansion can be easily done by qualified specialists on-site. Each circuit monitors and controls max. 20 luminaire addresses with a maximum current of 3A.

Each luminaire can be dimmed, addressed and programmed via the new touch controller. Settings of the functionalities at the luminaire modules are not required for our CLS FUSION system.

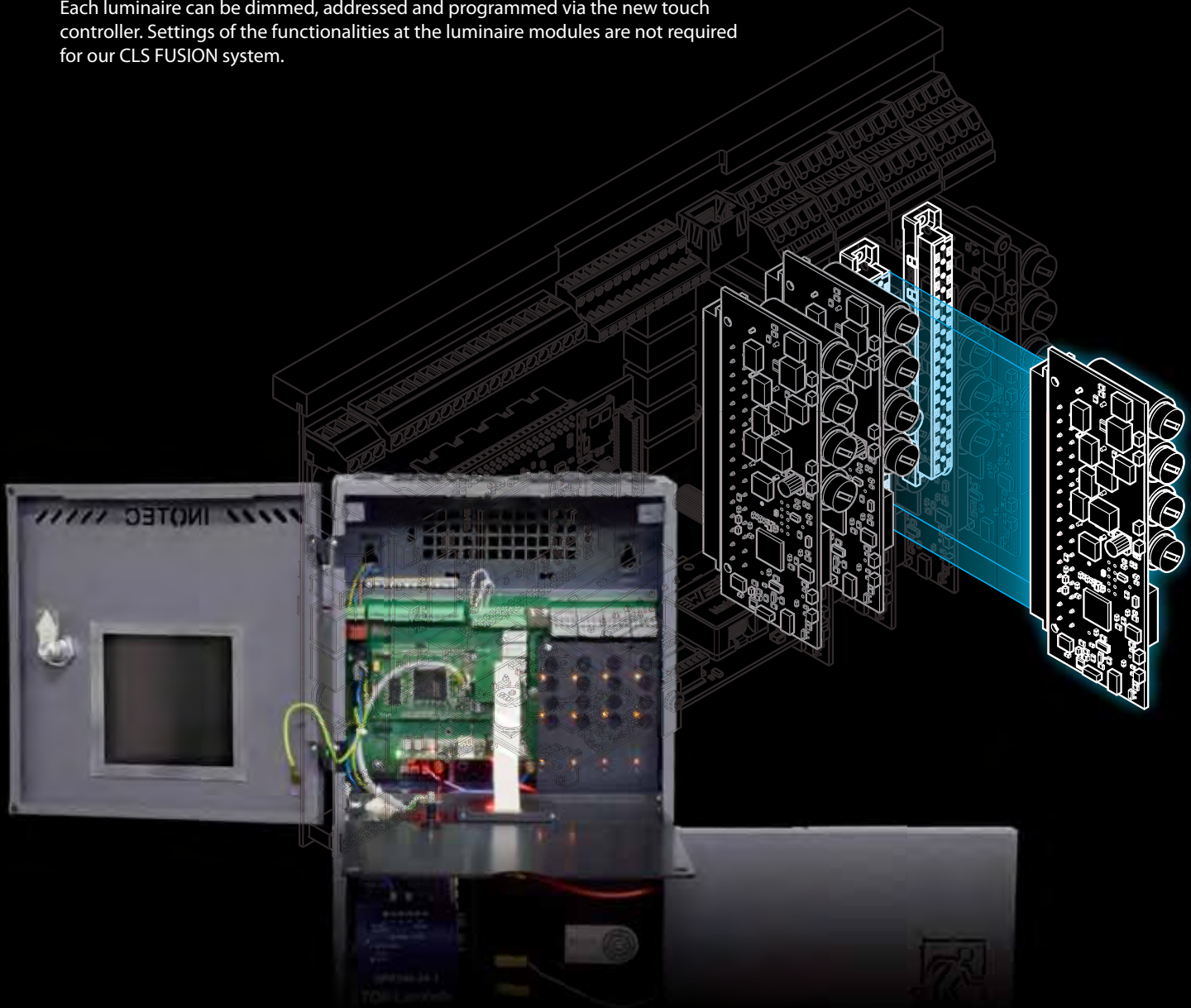

External BUS components

The functionality of the new CLS FUSION can be extended by connecting external, bus-compatible components such as light switch monitoring modules or three-phase monitoring. The bus-capable three-phase monitoring in particular enables the malfunctioning sub-distribution to be accurately reported on the CLS FUSION control unit and forwarded to a connected monitoring system.

A phase failure can be used for selective switching of individual luminaires or the triggering of dynamic escape route scenes.



LSA

3-phase monitoring relay

BUS-connection

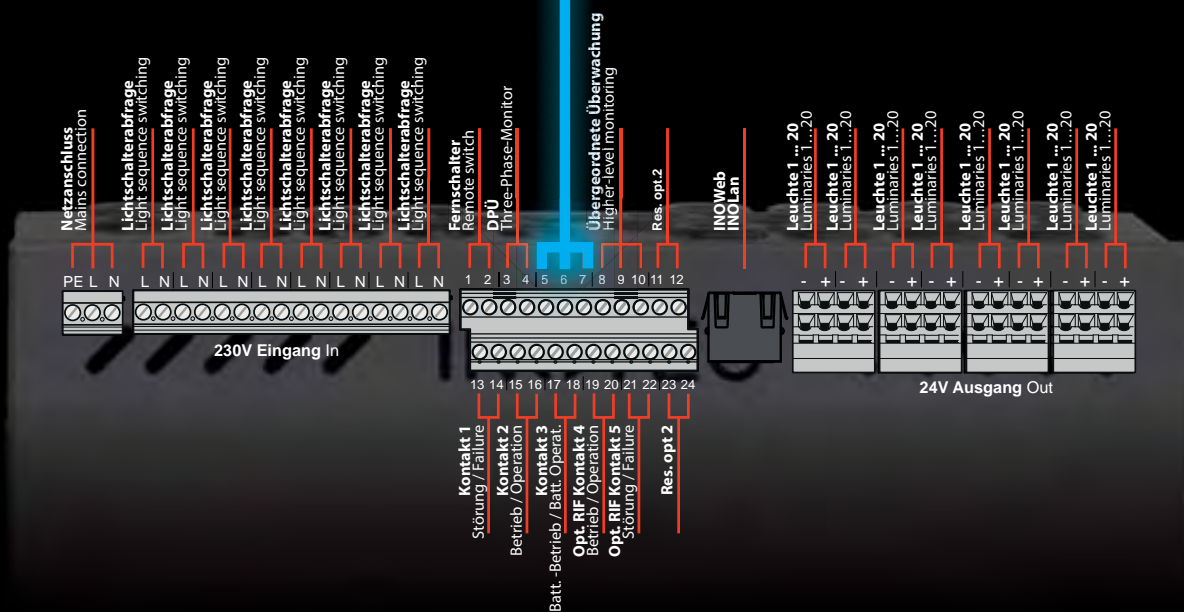



Individual LED monitoring

The individual LED monitoring in our FUSION systems does not only detect the high-impedance fault (interruption), but also the short circuit of a single LED. Our many years of experience in the field of LED safety and exit sign luminaires have shown that a short circuit in the LED is a frequent fault. More than 97% of defective LEDs have a short circuit in the "LED chip".

Until now this failure case was not identified by the luminaire monitoring and the faulty LED was not reported. The CLS FUSION technology offers the possibility to identify and report the failure.

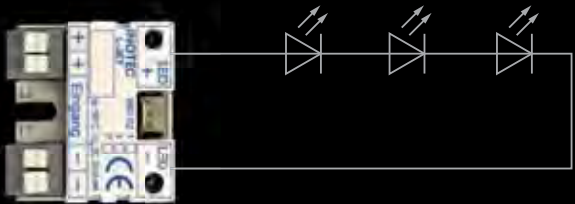
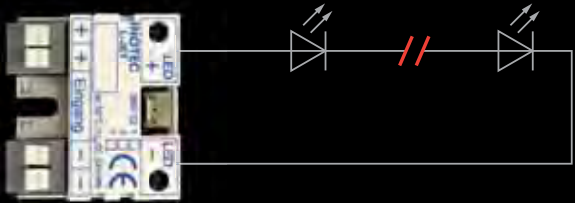
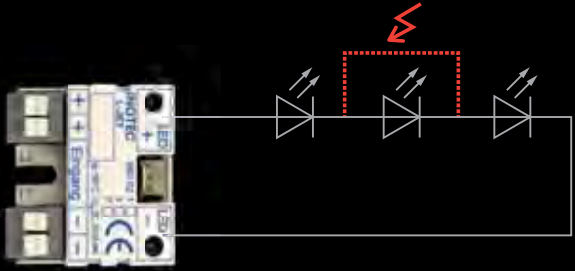
Luminaire status	Customary emergency lighting systems	FUSION
 <p>Operation</p>	Operation	Operation
 <p>Failure: LED defective (interruption)</p>	Failure	Failure
 <p>Failure: LED defective (short circuit)</p>	Operation	Failure

With powerful LEDs and corresponding secondary optics, safety luminaire are moreoften equipped with one LED only. Worst case an entire area of the escape route turns dark and the emergency lighting system does not report a luminaire failure.

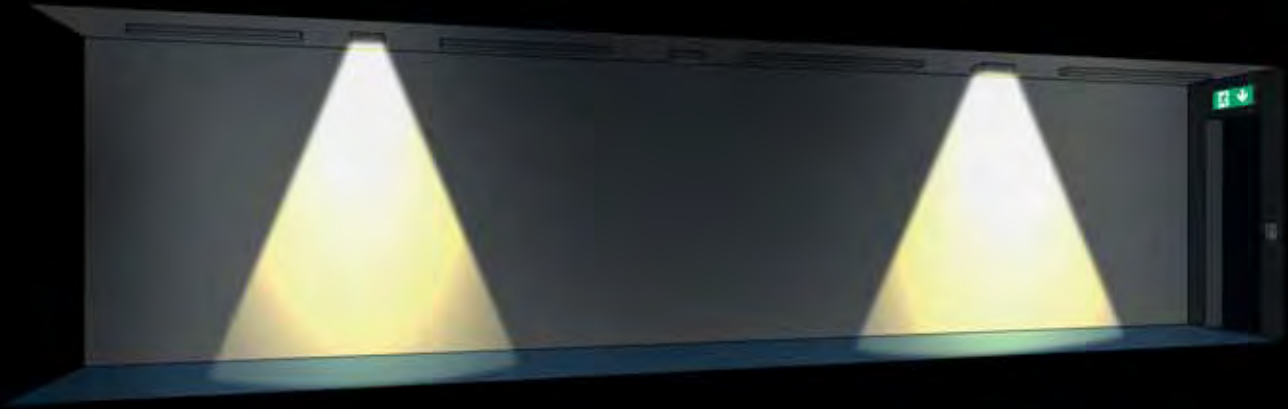

But even if several LEDs are used in a safety luminaire, a failure of a single LED might reduce the light output so that the illumination level of 1lx on the escape route as required in EN 1838 is not fulfilled any more.

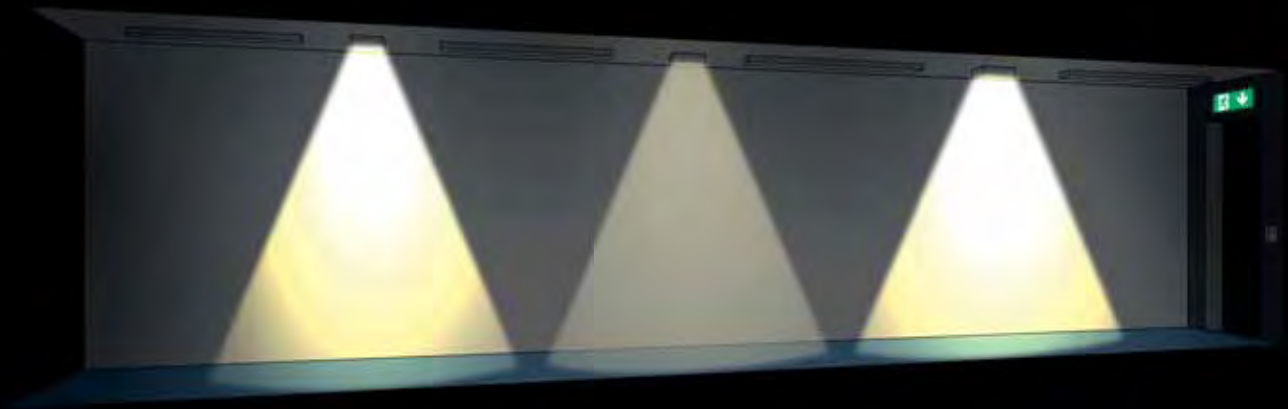

CLS FUSION systems offer a significant higher safety level than customary emergency lighting systems due to the identification of individual LED failures.



Battery-Control-System (BCS)

A failure in the standby power source of the emergency lighting system can have drastic consequences. This is why the maintaining and monitoring of the standby power source is top priority for us. Most emergency lighting systems monitor several battery blocks and cannot detect a failure of an individual battery block.

The integrated battery control system of the CLS FUSION offers more safety. It records the battery voltage of each individual battery block. This enables early detection of a defective battery block. In the worst case, a single defective battery block can also destroy the remaining blocks of the battery set.

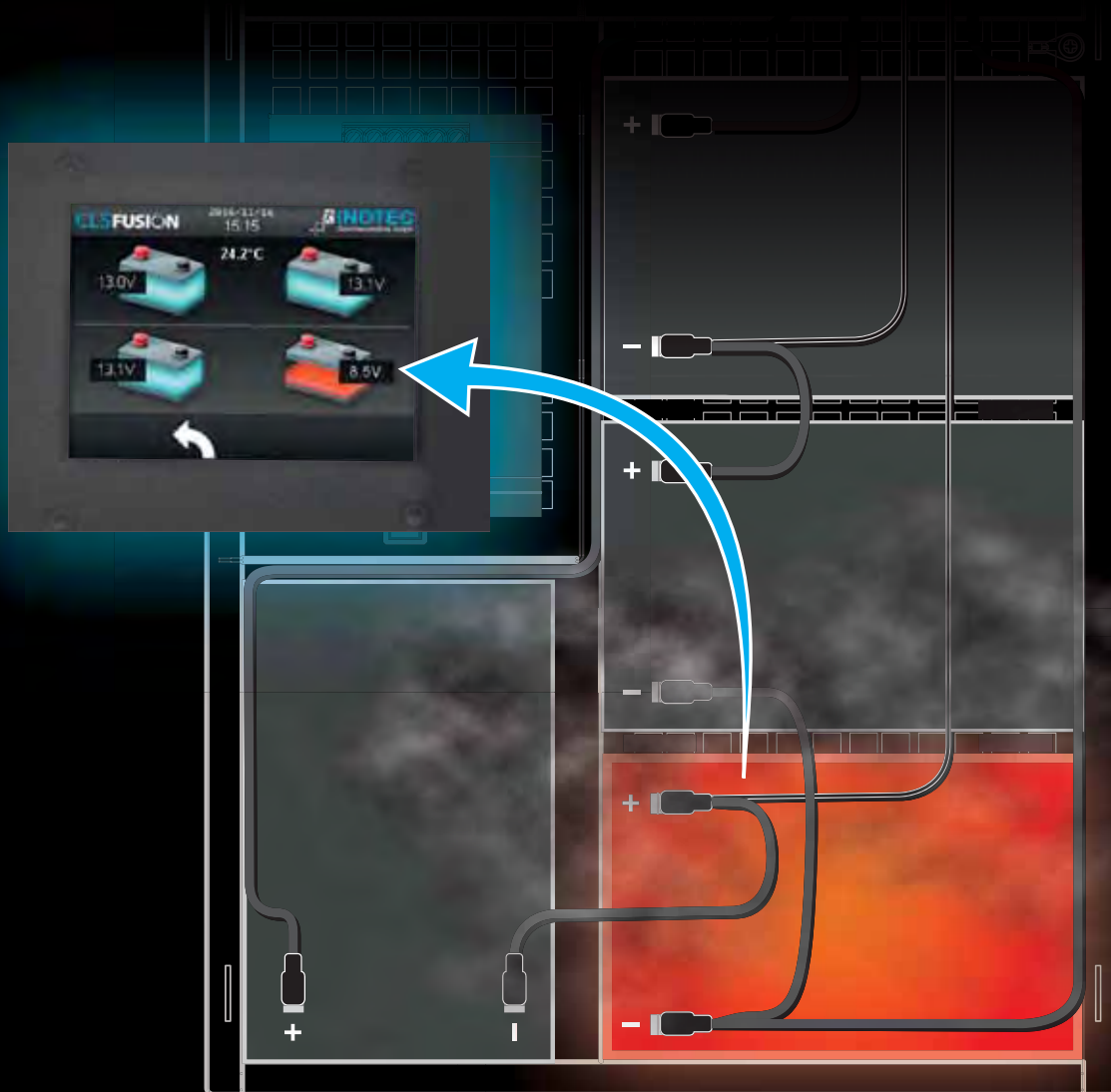

The requirements of the draft for prEN 50171:2013 are fulfilled by the Battery-Control-System (BCS) of the CLS FUSION:



- + Periodic monitoring of the battery block voltage (6.11.3. a)



- + Failure message in case of a deviation of the battery block voltage (6.11.3. b)



- + Only manual resetting of failure messages (6.11.3. d)



- + Recording of the battery block voltage during the battery duration test with an interval of 5 minutes (6.11.3. f)



- + Monitoring and recording the ambient temperature of the battery (6.11.4)

Ease of use

User-friendly operation

The modern, graphical user interface of the TFT touch display in our CLS FUSION system enables a user-friendly and intuitive operation.

The habits of the users changed a lot due to smartphones and tablets. INOTEC takes up the concepts and simplifies the usage of your emergency lighting systems.

All status information up to luminaire level are displayed on the 3.5" TFT-touch display of the CLS FUSION.

As a result of the consistent user interface for our centralised and decentralised emergency lighting systems the user does not need to adapt to a different usage.



Control up to luminaire level



Display logbook at the device

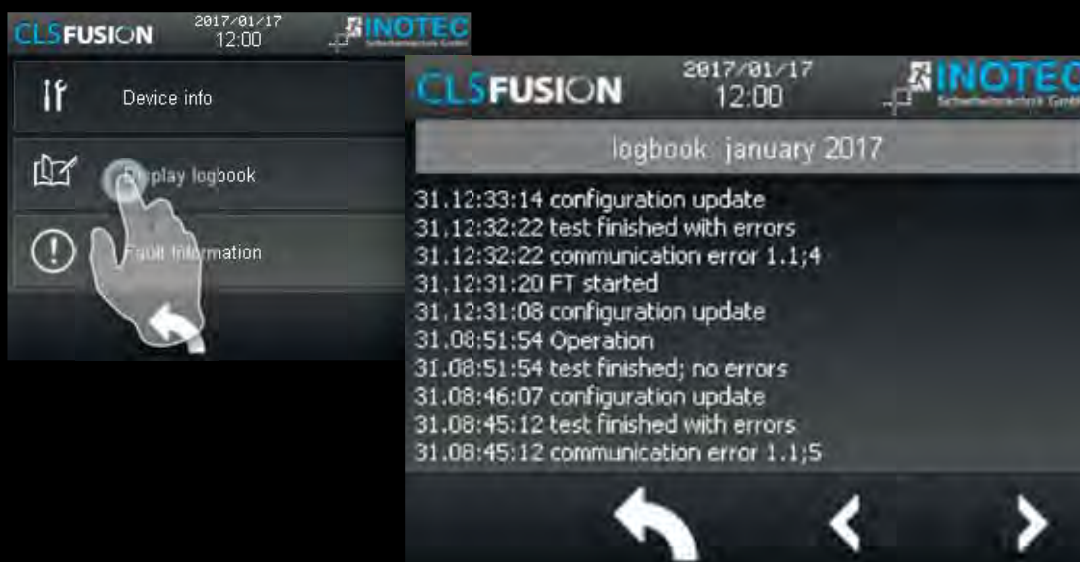



Connectivity

Numerous interfaces on the CLS FUSION controller unit offers a wide range of monitoring and programming options.

With the standardised USB interface, information can be stored on a USB pen drive or the configuration of the system can be updated. The control unit software can also be easily updated using USB.

The integrated network interface enables the transfer of information to monitoring systems. By default, the information can be accessed with a web browser via PC or mobile via INOWeb. All status information up to the individual luminaire malfunction is visualised.

The FUSION systems can be monitored with the INOView software. The status of luminaires, BCS and connected components is clearly displayed in INOView with destination text. Events are logged centrally in the test logbook of all monitored systems. For faster localisation of the faulty luminaire, these can be displayed in a floor plan with the current luminaire status.

Status messages to building management software can be transmitted via ModBUS/TCP. This allows information to be displayed up to the luminaire level in an existing building management system. Other standard building management system protocols such as OPC or BACnet can also be implemented with FUSION.

- + USB and network interface
- + INOView
- + RTG BUS
- + Transfer of status reports to building management systems (BMS)
 - + Modbus/TCP
 - + BACnet
 - + OPC
 - + LON
 - + KNX-Gateway

INOWeb



INOView



E-Mail

Modbus/TCP

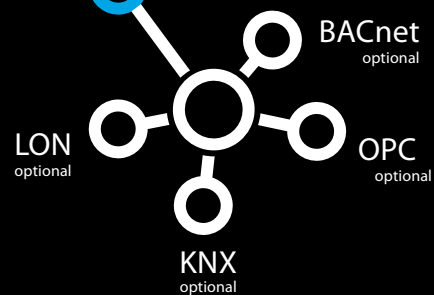



INOView - flexible monitoring

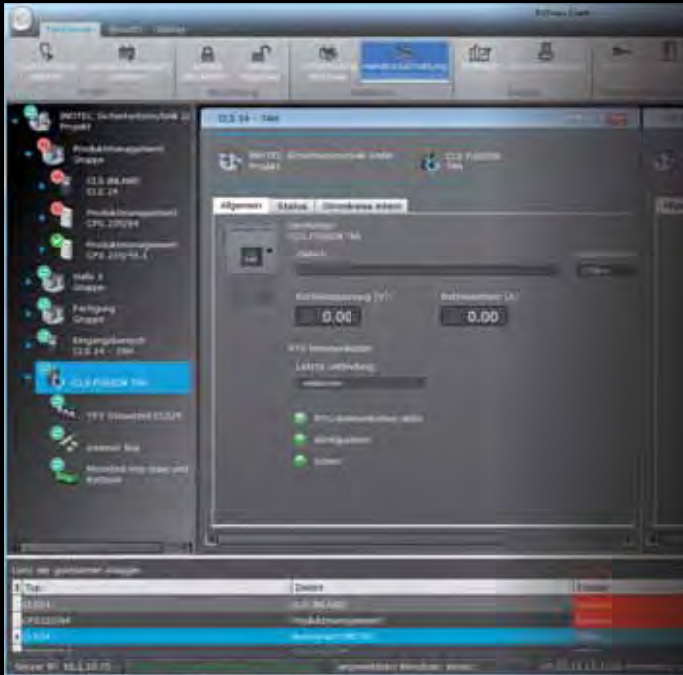

INOView is the central monitoring solution for all INOTEC emergency lighting systems. This software is used wherever a flexible application is required which grows with the project. The devices can be monitored either via a three-core RTG bus and/or network connection.

Everything in focus for personal safety in buildings

The ease of use was the main focus when developing the visualisation software INOView. Hereby the intuitive user interface was created with clearly structured system overviews and description texts. At just a glance, the user recognises the overall condition of the emergency lighting systems and may quickly take measures to guarantee the safety of people in the building. The INOView software ensures transparency and provides comprehensive and detailed information on the overall and detailed system status.

Modern client/server architecture

A modern client/server architecture ensures future and investment security. The clients allow several users in the network to access the information of the INOView software simultaneously. An integrated user administration protects the software from unauthorised access.

Powerful and easy to use

With the INOView-Software you can control your emergency lighting devices easily. Intuitive handling menus enable a simple and comfortable usage. Individual designable visualisations of the information help the transparency. Whether in school or at the airport, the INOView-Software meets the requirements of the customer with its modern standards.

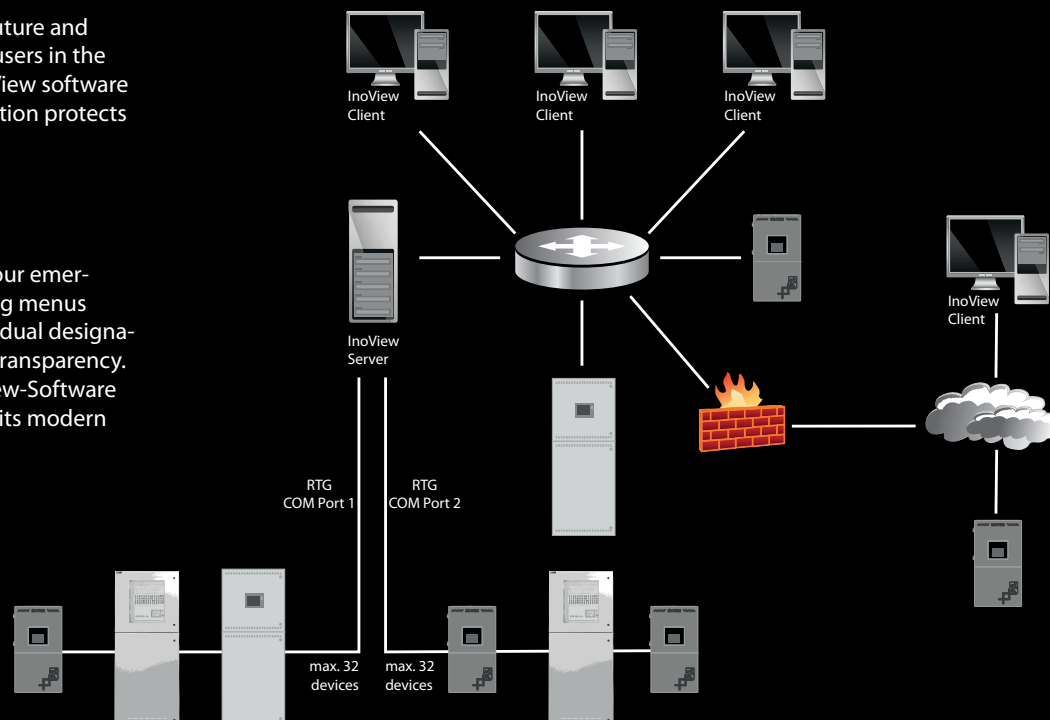

INOWeb

TFT-touch controller with integrated INOWeb function for central monitoring of the emergency lighting device via intra-/internet. The connection works via an already existing network.

By accessing the controller's INOWeb functionality via web browser the status of each system, circuit and luminaire can be checked on the (optionally) password-protected website.

With an existing connection to the Internet, monitoring is also possible via PC with Internet access. For demonstration purposes, please contact your regional technical sales team.

Functions:

- + Starting a function test/ battery duration test
- + Blocking /releasing
- + Failure printout
- + Linking files / websites by circuit

It is possible to monitor complex installations with different system types at one central position with the help of the software INOWeb-Control. Therefore the TFT-touch controller needs to be integrated in an existing network.

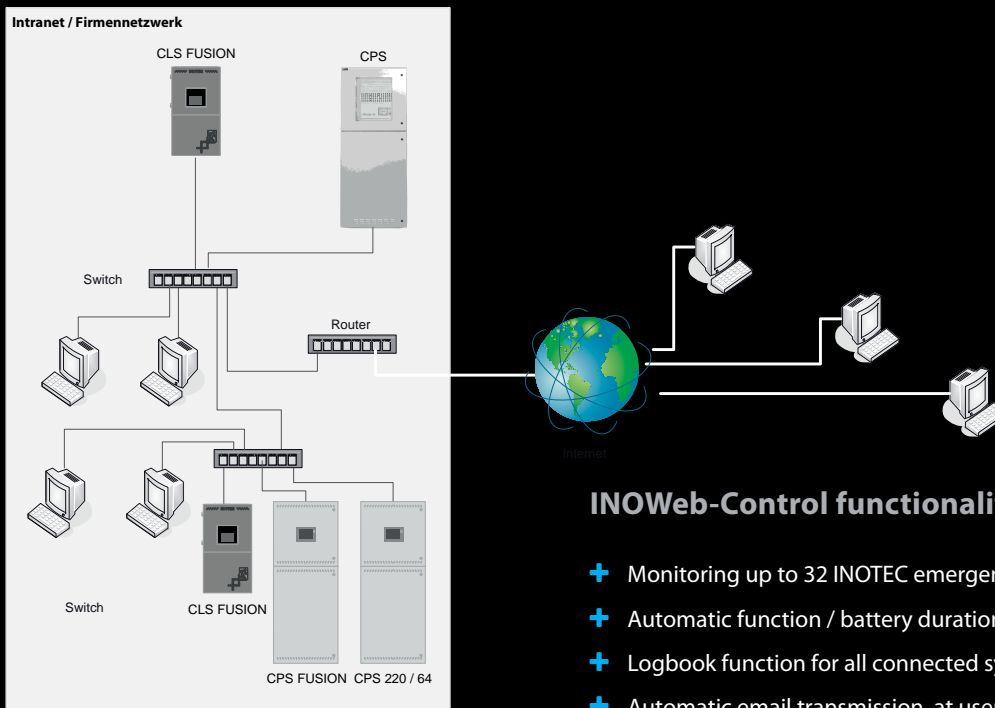
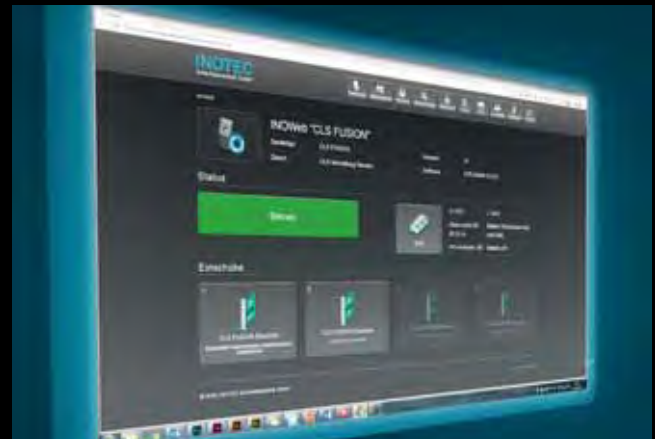

INOWeb-Control functionalities :

- + Monitoring up to 32 INOTEC emergency lighting systems
- + Automatic function / battery duration test programmable
- + Logbook function for all connected systems
- + Automatic email transmission, at user-defined intervals, in case of test or failure
- + Overall status of all systems is indicated by a symbol in the taskbar

Project design with a CLS FUSION system

1. Circuit design

- Define circuits and luminaires
- Sum the nominal currents
- Include the battery ageing reserve

CI1	SNP 1216 D 	SNP 1216 S 	SN 8424 SLB 	$\Sigma I_{sk1} = 1.23A$
	0.125A 3 pieces	0.125A 3 pieces	0.120A 4 pieces	
CI2	SNP 1214 D 	SN 9424 ALB 		$\Sigma I_{sk2} = 0.595A$
	0.100A 4 pieces	0.065A 3 pieces		
CI3	SNP 1530 D 	SNP 6204.2 	FL 1530 (D.E.R.) 	$\Sigma I_{sk3} = 1.24A$
	0.180A 3 pieces	0.150A 2 pieces	0.200A 2 pieces	
CI4	SNP 1530 D 	SNP 1530 S 	SN 9100 TES 	$\Sigma I_{sk4} = 1.32A$
	0.180A 2 pieces	0.180A 2 pieces	0.200A 3 pieces	

Total current = 4.385A

Total current incl. battery ageing reserve (12.5%) acc. to to EN 50171 = **4.933A**

2. Selection of the system type

After specifying the nominal operating time e.g. 3hours, see DIN V VDE V 0108

Rated duration	CLS FUSION 7Ah	CLS FUSION 12Ah	CLS FUSION 24Ah	CLS FUSION Power 24Ah	CLS FUSION Power 48Ah
1h	3.0A	7.4A	7.0A	15.5A	13.4A
3h	1.7A	2.8A	5.9A	6.1A	12.5A
8h	0.6A	1.2A	2.6A	2.8A	5.9A
Power loss	17W	40W	43W	77W	83W

3. Determination of the cable cross-section / max. cable length per final circuit

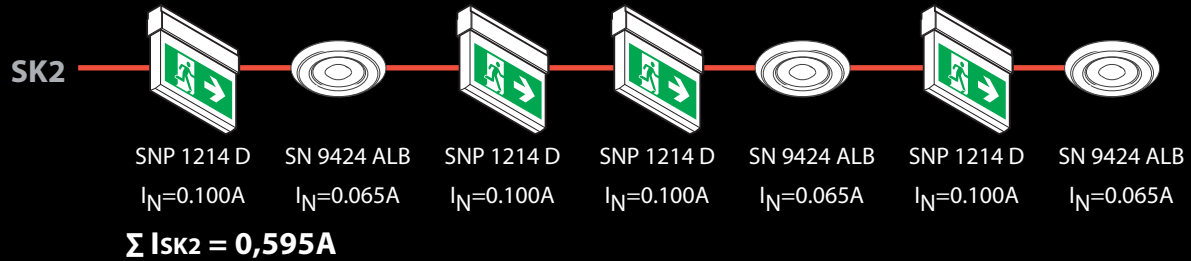

$$A = \frac{2 \cdot \text{cable length} \cdot \text{current}}{\text{Conductivity value} \cdot \text{max. voltage drop}} = \frac{2 \cdot 200\text{m} \cdot 1.00A}{56 \frac{\text{m}}{\Omega \cdot \text{mm}^2} \cdot 3.5V} = 2.04\text{mm}^2 \Rightarrow 2.5\text{mm}^2$$

The max. voltage drop in the final circuit may be 3.5V for CLS FUSION systems.

Max. cable length based on the max. voltage drop:

Current	cross-section	max. length
3A	1.5mm ²	49m
2A	1.5mm ²	74m
1A	1.5mm ²	147m
3A	2.5mm ²	82m
2A	2.5mm ²	123m
1A	2.5mm ²	245m

4. Ventilation and cooling

According to the formula for the required air volume flow

$$Q = v \cdot q \cdot s \cdot n \cdot I_{gas} \cdot C_N \cdot 10^{-3} [\text{m}^3/\text{h}]$$

the required air flow volumes and ventilation holes are:

System	Required air volume flow	Ventilation hole
CLS FUSION – 7Ah	0.004m ³ /h	0.1cm ²
CLS FUSION – 12Ah	0.007m ³ /h	0.2cm ²
CLS FUSION – 24Ah	0.015m ³ /h	0.42cm ²
CLS FUSION – Power – 24Ah	0.016m ³ /h	0.45cm ²
CLS FUSION – Power – 48Ah	0.031m ³ /h	0.87cm ²

The ventilation and cooling can work via the general room ventilation based on the required ventilation hole.

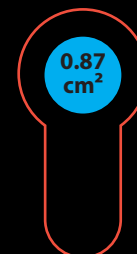

Size comparison*
required ventilation hole CLS FUSION
vs. Standard profile cylinder

* Scale 1:1

Protection class: I
 Protection category: IP20
 Perm. ambient temp.: -5°C to +25°C
 Battery: 24V
 Colour: RAL 7015 - L16

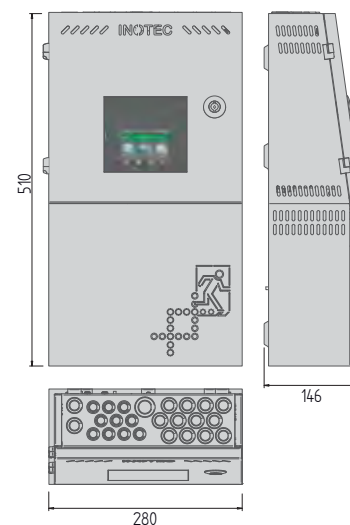
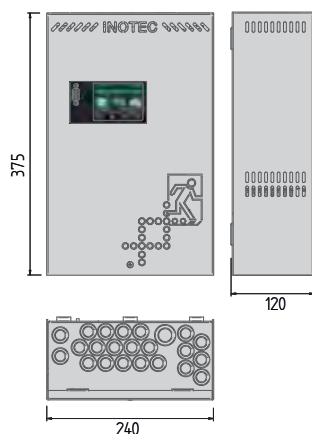

CLS FUSION - 7Ah

CLS FUSION - 12Ah

Supply voltage:	230V AC +/-10%	230V AC +/-10%
Max. input current:	0.6A	2.2A
Mains fuse:	5AT, BC=1500A	5AT, BC=1500A
Output voltage:	24V DC +/-20%	24V DC +/-20%
Final circuits:	4	8
Max. load:	3A per circuit	3A per circuit
Final circuit fuse:	5AT, BC=1500A	5AT, BC=1500A
Max. cable cross section for:		
Mains:	4 mm ²	4 mm ²
LSA:	4 mm ²	4 mm ²
Final circuits:	2.5 mm ²	2.5 mm ²
Signalling contacts:	1.5 mm ²	1.5 mm ²
Weight:	approx. 10kg	approx. 17kg
Dimensions: H x W x D:	375 x 240 x 120 mm	510 x 280 x 146 mm
Cabinets:		
Sheet steel cabinet, IP20	800 x 400 x 210 mm	800 x 400 x 210 mm
Sheet steel cabinet IP54	800 x 400 x 210 mm	800 x 400 x 210 mm
Fire protection cabinet BRS40	1198 x 648 x 449 mm	1198 x 648 x 449 mm
Battery:	24V/7.2Ah	24V/12Ah
Battery fuse:	30A, BC=1000A	30A, BC=1000A
Converter fuse:	30A, BC=1000A	30A, BC=1000A
Max. discharge current* for a rated duration of:		
1h	3.0A	7.4A
3h	1.7A	2.8A
8h	-	1.2A

*ageing reserve not included

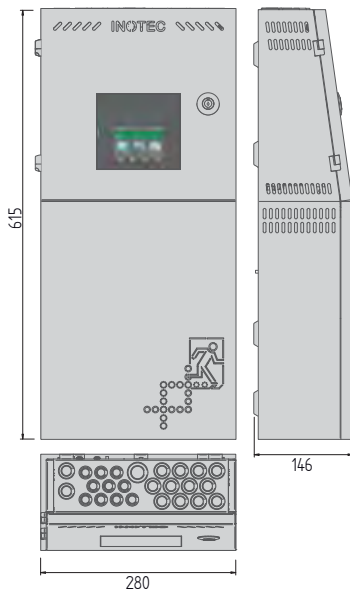

CLS FUSION - 24Ah

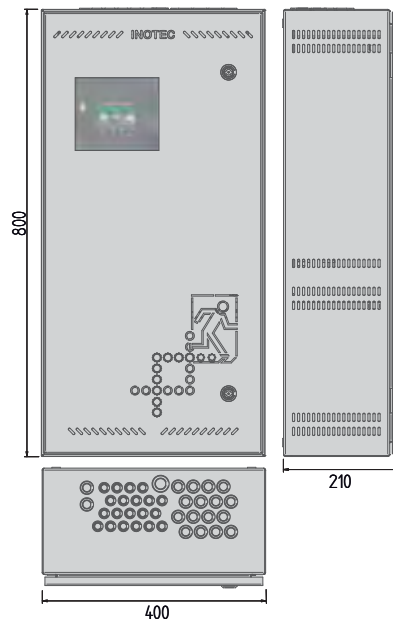

CLS FUSION - POWER - 24Ah

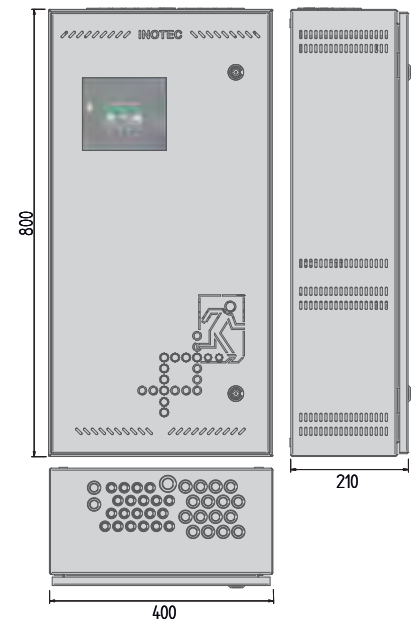

CLS FUSION - POWER - 48Ah

230V AC +/-10%

2.2A

5AT, BC=1500A

24V DC +/-20%

8

3A per circuit

5AT, AV=1500A

4 mm²

4 mm²

2.5 mm²

1.5 mm²

approx. 25kg

615 x 280 x 146 mm

800 x 400 x 210 mm

800 x 400 x 210 mm

1198 x 648 x 449 mm

24V/24Ah

30A, BC=1000A

30A, BC=1000A

7.0A

5.9A

2.6A

230V AC +/-10%

3.5A

5AT, BC=1500A

24V DC +/-20%

8

3A per circuit

5AT, BC=1500A

4 mm²

4 mm²

2.5 mm²

1.5 mm²

approx. 39kg

800 x 400 x 210 mm

800 x 400 x 210 mm

1198 x 648 x 449 mm

24V/24Ah

30A, BC=1000A

30A, BC=1000A

15.5A

6.1A

2.8A

230V AC +/-10%

3.5A

5AT, BC=1500A

24V DC +/-20%

8

3A per circuit

5AT, BC=1500A

4 mm²

4 mm²

2.5 mm²

1.5 mm²

approx. 54kg

800 x 400 x 210 mm

800 x 400 x 210 mm

1198 x 648 x 449 mm

24V/48Ah

30A, BC=1000A

30A, BC=1000A

13.4A

12.5A

5.9A

Decentral emergency lighting system for operating and monitoring of INOTEC LED 24V safety and emergency exit luminaires.

CLS FUSION - 7Ah

wall housing

Art. Nr. 934030V

Technical data

Nominal voltage: 230V AC +/-10%

max. Input current: 0.6A

Mains fuse: 5AT, IR=1500A

Output voltage: 24V DC +/-20%

Amb. temp. range: -5°C until +25°C

Without fan yes

Final circuits: 4

max. load: 3A per final circuit

Final circuit fuses: 5AT, IR=1500A

Protection class: I

Protection category: IP20

max. cross section for

Mains: 4 mm²

LSA: 4 mm²

Final circuits: 2.5 mm²

Voltfree signalling contacts: 1.5 mm²

Weight: approx. 10kg

Dimensions: 375 x 240 x 120 mm

Cabinet options

Sheet steel wall cabinet IP20: 800 x 400 x 210 mm

Sheet steel wall cabinet IP54: 800 x 400 x 210 mm

Fire protection cabinet BRS40: 1198 x 648 x 449 mm

Battery: 24V/7.2Ah

Battery fuse: 30A, IR=1000A

Converter fuse: 30A, IR=1000A

Battery power:

1h 3.0A

2h 2.5A

3h 1.7A

8h -

Battery power without aging reserve

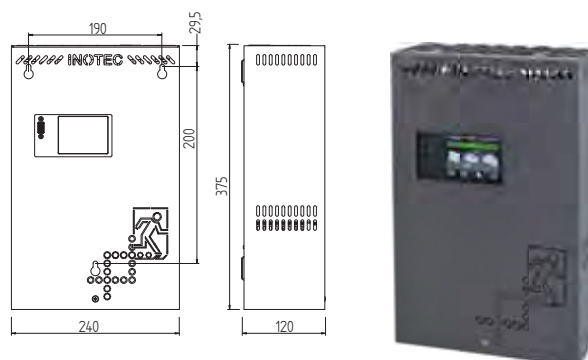

Decentral emergency lighting system for operating and monitoring of INOTEC LED 24V safety and emergency exit luminaires.

CLS FUSION - 7Ah - MV

Art. Nr. 934 033V

Mounting variant for cabinet installation

Technical data

Nominal voltage: 230V AC +/-10%
max. Input current: 0.6A
Mains fuse: 5AT, IR=1500A
Output voltage: 24V DC +/-20%
Amb. temp. range: -5°C until +25°C

Final circuits: 4
max. load: 3A per final circuit
Final circuit fuses: 5AT, IR=1500A
Protection class: I

max. cross section for

Mains: 4 mm²
LSA: 4 mm²
Final circuits: 2.5 mm²
Voltfree signalling contacts: 1.5 mm²

Battery: 24V/7.2Ah
Battery fuse: 30A, IR=1000A
Converter fuse: 30A, IR=1000A

Battery power:

1h 3.0A
2h 2.5A
3h 1.7A
8h -

Battery power without aging reserve

Cabinet options

Sheet steel wall cabinet IP20: 800 x 400 x 210 mm
Weight: approx. 18kg
Fan: no

Sheet steel wall cabinet IP54: 800 x 400 x 210 mm
Weight: approx. 18kg
Fan: yes
Noise level: approx. 40dB

Fire protection cabinet BRS40: 1198 x 648 x 449 mm
Weight: approx. 160kg
Fan: yes
Noise level: approx. 40dB

CLS FUSION - 7Ah - Sheet steel wall cabinet IP20

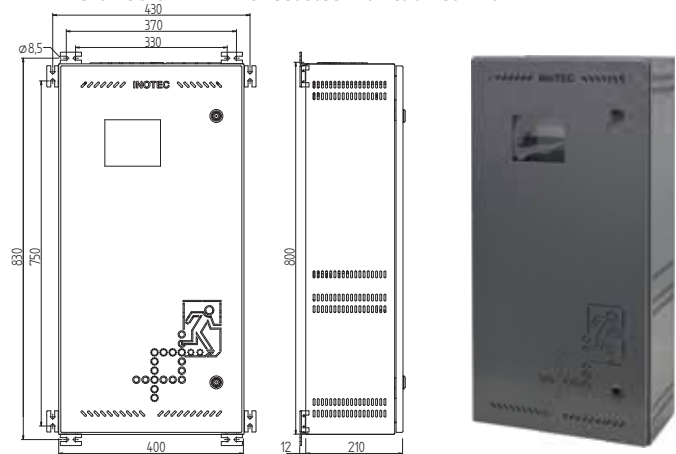

CLS FUSION - 7Ah - Sheet steel wall cabinet IP54

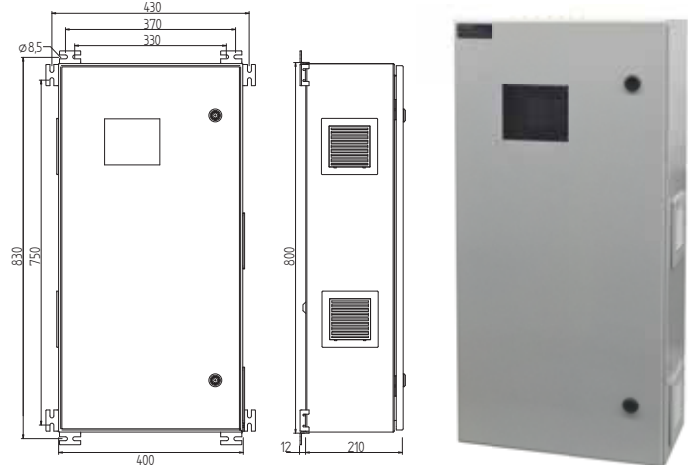

CLS FUSION - 7Ah - Fire protection cabinet BRS40

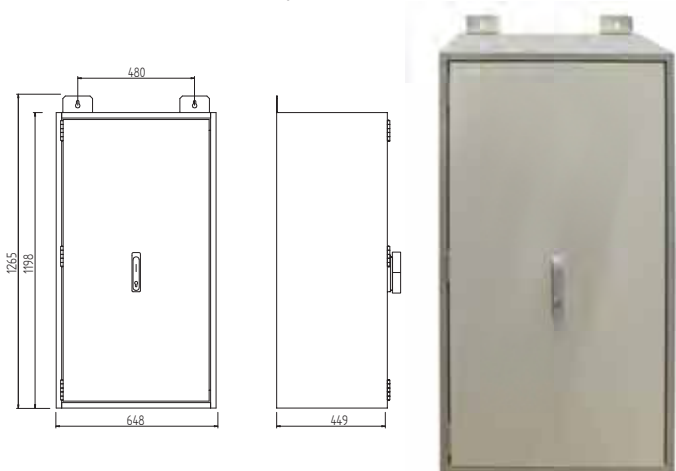

Decentral emergency lighting system for operating and monitoring of INOTEC LED 24V safety and emergency exit luminaires.

Technical data

Nominal voltage: 230V AC +/-10%
max. Input current: 2.2A
Mains fuse: 5AT, IR=1500A
Output voltage: 24V DC +/-20%
Amb. temp. range: -5°C until +25°C
Without fan: yes

Final circuits: 8
max. load: 3A per final circuit
Final circuit fuses: 5AT, IR=1500A
Protection class: I
Protection category: IP20

max. cross section for

Mains: 4 mm²
LSA: 4 mm²
Final circuits: 2.5 mm²
Voltfree signalling contacts: 1.5 mm²

Weight: approx. 17kg
Dimensions: 510 x 280 x 142 mm

Cabinet options

Sheet steel wall cabinet IP20: 800 x 400 x 210 mm
Sheet steel wall cabinet IP54: 800 x 400 x 210 mm
Fire protection cabinet BRS40: 1198 x 648 x 449 mm

Battery: 24V/12Ah
Battery fuse: 30A, IR=1000A
Converter fuse: 30A, IR=1000A

Battery power:

1h 7.4A
2h 3.9A
3h 2.8A
8h 1.2A

Battery power without aging reserve

CLS FUSION - 12Ah

Art. Nr. 934 031V

wall housing

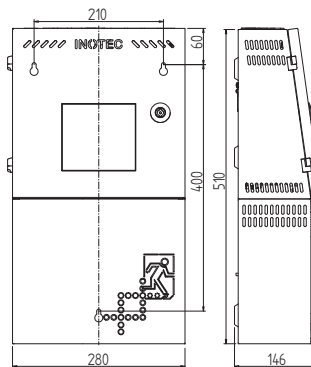

Decentral emergency lighting system for operating and monitoring of INOTEC LED 24V safety and emergency exit luminaires.

Technical data

Nominal voltage: 230V AC +/-10%
max. Input current: 2.2A
Mains fuse: 5AT, IR=1500A
Output voltage: 24V DC +/-20%
Amb. temp. range: -5°C until +25°C

Final circuits: 8
max. load: 3A per final circuit
Final circuit fuses: 5AT, IR=1500A
Protection class: I

max. cross section for

Mains: 4 mm²
LSA: 4 mm²
Final circuits: 2.5 mm²
Voltfree signalling contacts: 1.5 mm²

Battery: 24V/12Ah
Battery fuse: 30A, IR=1000A
Converter fuse: 30A, IR=1000A

Battery power:

1h 7.4A
2h 3.9A
3h 2.8A
8h 1.2A

Battery power without aging reserve

Cabinet options

Sheet steel wall cabinet IP20: 800 x 400 x 210 mm
Weight: approx. 25kg
Fan: no

Sheet steel wall cabinet IP54: 800 x 400 x 210 mm
Weight: approx. 18kg
Fan: yes
Noise level: approx. 40dB

Fire protection cabinet BR540: 1198 x 648 x 449 mm
Weight: approx. 160kg
Fan: yes
Noise level: approx. 40dB

CLS FUSION - 12Ah - MV

Art. Nr. 934 034V

Mounting variant for cabinet installation

CLS FUSION - 12Ah - Sheet steel wall cabinet IP20

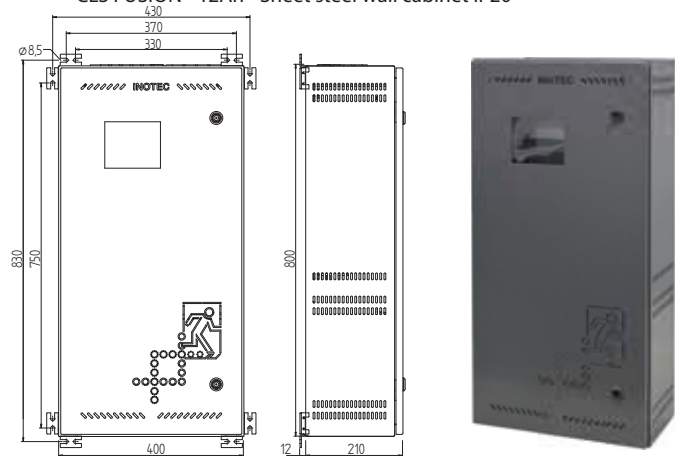

CLS FUSION - 12Ah - Sheet steel wall cabinet IP54

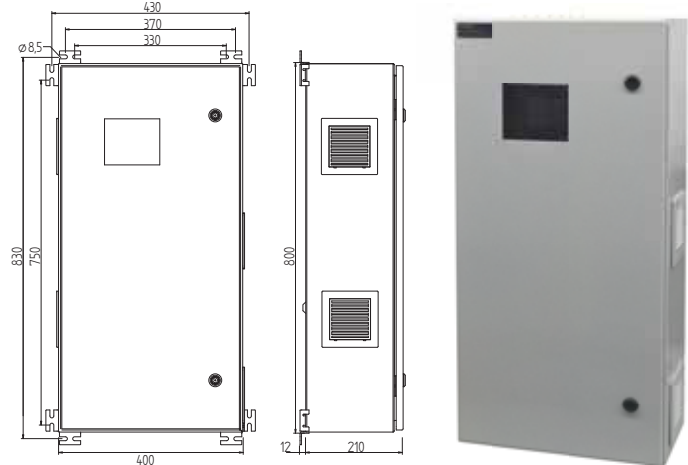

CLS FUSION - 12Ah - Fire protection cabinet BR540

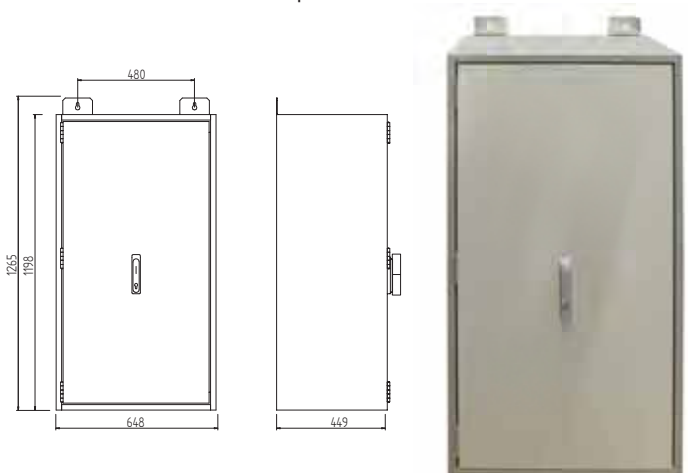

Decentral emergency lighting system for operating and monitoring of INOTEC LED 24V safety and emergency exit luminaires.

CLS FUSION - 24Ah

wall housing

Art. Nr. 934 032V

Technical data

Nominal voltage: 230V AC +/-10%

max. Input current: 2.2A

Mains fuse: 5AT, IR=1500A

Output voltage: 24V DC +/-20%

Amb. temp. range: -5°C until +25°C

Without fan: yes

Final circuits: 8

max. load: 3A per final circuit

Final circuit fuses: 5AT, IR=1500A

Protection class: I

Protection category: IP20

max. cross section for

Mains: 4 mm²

LSA: 4 mm²

Final circuits: 2.5 mm²

Voltfree signalling contacts: 1.5 mm²

Weight: approx. 25kg

Dimensions: 615 x 280 x 142 mm

Cabinet options

Sheet steel wall cabinet IP20: 800 x 400 x 210 mm

Sheet steel wall cabinet IP54: 800 x 400 x 210 mm

Fire protection cabinet BRS40: 1198 x 648 x 449 mm

Battery: 24V/24Ah

Battery fuse: 30A, IR=1000A

Converter fuse: 30A, IR=1000A

Battery power:

1h 7.0A

2h 7.0A

3h 5.9A

8h 2.6A

Battery power without aging reserve

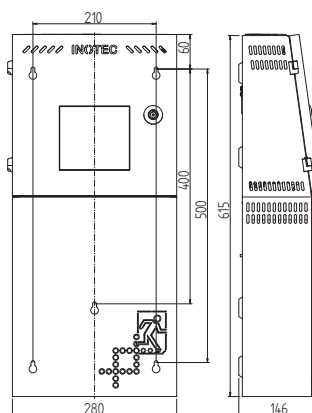

Decentral emergency lighting system for operating and monitoring of INOTEC LED 24V safety and emergency exit luminaires.

CLS FUSION - 24Ah - MV

Art. Nr. 934 035V

Mounting variant for cabinet installation

Technical data

Nominal voltage: 230V AC +/-10%
max. Input current: 2.2A
Mains fuse: 5AT, IR=1500A
Output voltage: 24V DC +/-20%
Amb. temp. range: -5°C until +25°C

Final circuits: 8
max. load: 3A per final circuit
Final circuit fuses: 5AT, IR=1500A
Protection class: I

max. cross section for

Mains: 4 mm²
LSA: 4 mm²
Final circuits: 2.5 mm²
Voltfree signalling contacts: 1.5 mm²

Battery: 24V/24Ah
Battery fuse: 30A, IR=1000A
Converter fuse: 30A, IR=1000A

Battery power:

1h 7.0A
2h 7.0A
3h 5.9A
8h 2.6A

Battery power without aging reserve

Cabinet options

Sheet steel wall cabinet IP20: 800 x 400 x 210 mm
Weight: approx. 33kg
Fan: no

Sheet steel wall cabinet IP54: 800 x 400 x 210 mm
Weight: approx. 18kg
Fan: yes
Noise level: approx. 40dB

Fire protection cabinet BRS40: 1198 x 648 x 449 mm
Weight: approx. 160kg
Fan: yes
Noise level: approx. 40dB

CLS FUSION - 24Ah - Sheet steel wall cabinet IP20

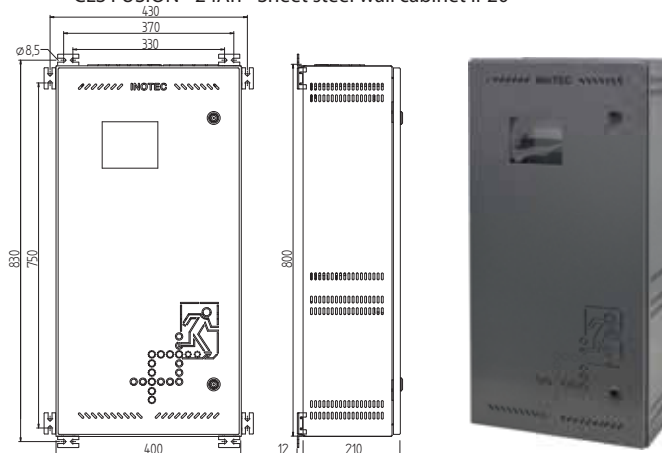

CLS FUSION - 24Ah - Sheet steel wall cabinet IP54

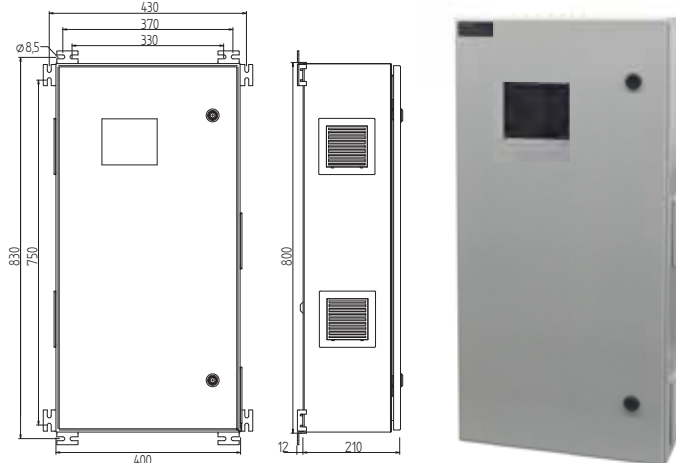

CLS FUSION - 24Ah - Fire protection cabinet BRS40

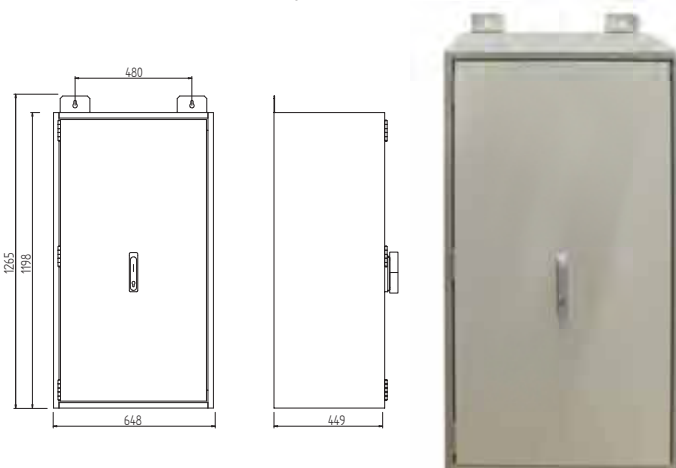

Decentral emergency lighting system for operating and monitoring of INOTEC LED 24V safety and emergency exit luminaires.

CLS FUSION - POWER - 24Ah

wall housing

Art. Nr. 934 036V

Technical data

Nominal voltage:	230V AC +/-10%
max. Input current:	3.5A
Mains fuse:	5AT, IR=1500A
Output voltage:	24V DC +/-20%
Amb. temp. range:	-5°C until +25°C
Without fan:	yes

Final circuits:	8
max. load:	3A per final circuit
Final circuit fuses:	5AT, IR=1500A
Protection class:	I
Protection category:	IP20

max. cross section for

Mains:	4 mm ²
LSA:	4 mm ²
Final circuits:	2.5 mm ²
Voltfree signalling contacts	1.5 mm ²

Weight:	approx. 39kg
Dimensions:	800 x 400 x 210 mm

Cabinet options

Sheet steel wall cabinet IP54:	800 x 400 x 210 mm
Fire protection cabinet BRS40:	1198 x 648 x 449 mm

Battery:	24V/24Ah
Battery fuse:	30A, IR=1000A
Converter fuse:	30A, IR=1000A

Battery power:

1h	15.5A
2h	8.7A
3h	6.1A
8h	2.8A

Battery power without aging reserve

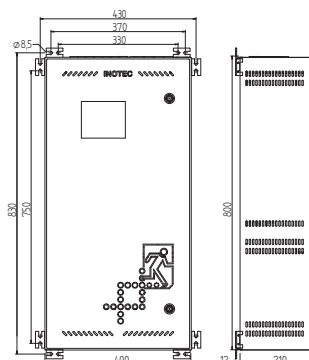

Decentral emergency lighting system for operating and monitoring of INOTEC LED 24V safety and emergency exit luminaires.

CLS FUSION - POWER - 24Ah - MV

Art. Nr. 934038V

Mounting variant for cabinet installation

Technical data

Nominal voltage: 230V AC +/-10%
max. Input current: 3.5A
Mains fuse: 5AT, IR=1500A
Output voltage: 24V DC +/-20%
Amb. temp. range: -5°C until +25°C

Final circuits: 8
max. load: 3A per final circuit
Final circuit fuses: 5AT, IR=1500A
Protection class: I

max. cross section for

Mains: 4 mm²
LSA: 4 mm²
Final circuits: 2.5 mm²
Voltfree signalling contacts: 1.5 mm²

Battery: 24V/24Ah
Battery fuse: 30A, IR=1000A
Converter fuse: 30A, IR=1000A

Battery power:

1h 15.5A
2h 8.7A
3h 6.1A
8h 2.8A

Battery power without aging reserve

Cabinet options

Sheet steel wall cabinet IP54: 800 x 400 x 210 mm
Weight: approx. 18kg
Fan: yes
Noise level: approx. 40dB

Fire protection cabinet BR540:

1198 x 648 x 449 mm
Weight: approx. 160kg
Fan: yes
Noise level: approx. 40dB

CLS FUSION - POWER - 24Ah - Sheet steel wall cabinet IP54

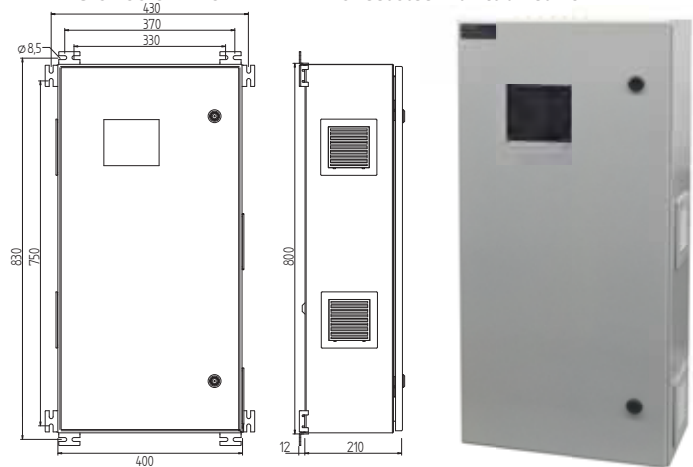

CLS FUSION - POWER - 24Ah - Fire protection cabinet BR540

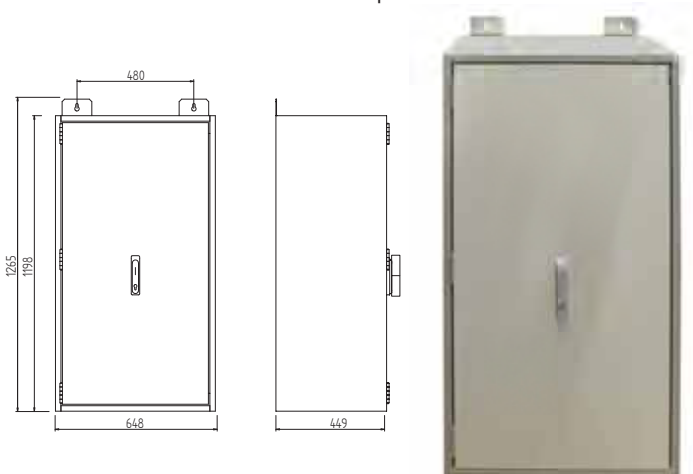

Decentral emergency lighting system for operating and monitoring of INOTEC LED 24V safety and emergency exit luminaires.

CLS FUSION - POWER - 48Ah

wall housing

Art. Nr. 934 037V

Technical data

Nominal voltage:	230V AC +/-10%
max. Input current:	3.5A
Mains fuse:	5AT, IR=1500A
Output voltage:	24V DC +/-20%
Amb. temp. range:	-5°C until +25°C
Without fan:	no

Final circuits:	8
max. load:	3A per final circuit
Final circuit fuses:	5AT, IR=1500A
Protection class:	I
Protection category:	IP20

max. cross section for

Mains:	4 mm ²
LSA:	4 mm ²
Final circuits:	2.5 mm ²
Voltfree signalling contacts:	1.5 mm ²

Weight:	approx. 54kg
Dimensions:	800 x 400 x 210 mm

Cabinet options

Sheet steel wall cabinet IP54:	800 x 400 x 210 mm
Fire protection cabinet BRS40:	1198 x 648 x 449 mm

Battery:	24V/48Ah
Battery fuse:	30A, IR=1000A
Converter fuse:	30A, IR=1000A

Battery power:

1h	13.4A
2h	13.4A
3h	12.5A
8h	5.9A

Battery power without aging reserve

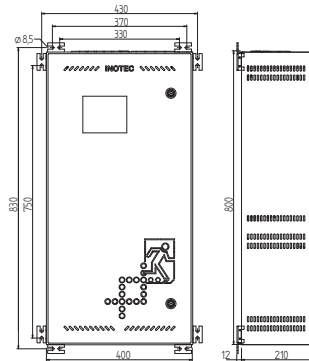

Decentral emergency lighting system for operating and monitoring of INOTEC LED 24V safety and emergency exit luminaires.

Technical data

Nominal voltage: 230V AC +/-10%
max. Input current: 3.5A
Mains fuse: 5AT, IR=1500A
Output voltage: 24V DC +/-20%
Amb. temp. range: -5°C until +25°C

Final circuits: 8
max. load: 3A per final circuit
Final circuit fuses: 5AT, IR=1500A
Protection class: I

max. cross section for

Mains: 4 mm²
LSA: 4 mm²
Final circuits: 2.5 mm²
Voltfree signalling contacts: 1.5 mm²

Battery: 24V/48Ah
Battery fuse: 30A, IR=1000A
Converter fuse: 30A, IR=1000A

Battery power:

1h 13.4A
2h 13.4A
3h 12.5A
8h 5.9A

Battery power without aging reserve

Cabinet options

Sheet steel wall cabinet IP54: 800 x 400 x 210 mm
Weight: approx. 18kg
Fan: yes
Noise level: approx. 40dB

Fire protection cabinet BRS40: 1198 x 648 x 449 mm
Weight: approx. 160kg
Fan: yes
Noise level: approx. 40dB

CLS FUSION - POWER - 48Ah - MV

Art. Nr. 934039V

Mounting variant for cabinet installation

CLS FUSION - POWER - 48Ah - Sheet steel wall cabinet IP54

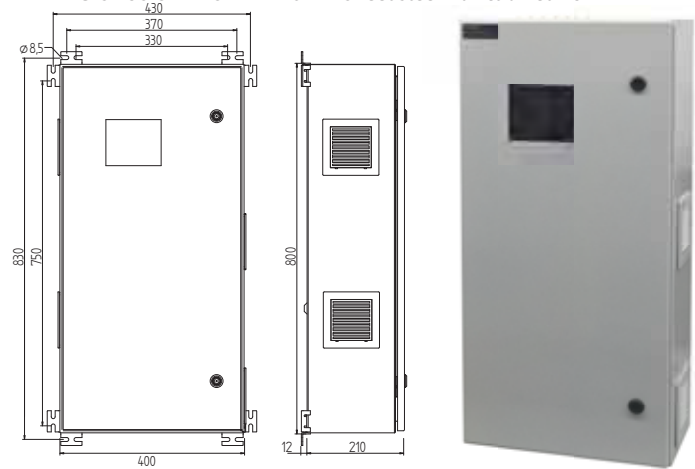

CLS FUSION - POWER - 48Ah - Fire protection cabinet BRS40 BRS40

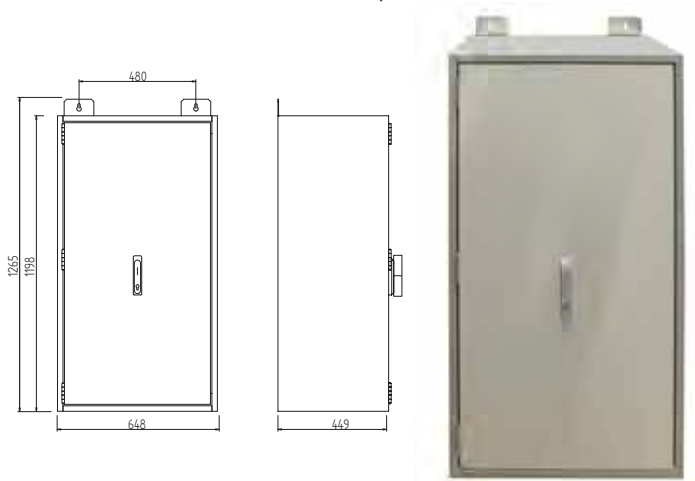

For voltage monitoring of sub distribution boards. Detailed phase failure information and location details in plain text at the controller unit.

Equipped with two voltage-free n/o signalling contacts.

- LED indicators for L1, L2, L3
- Any phase sequence
- Detection of undervoltage and mains failure in three-phase network
- Can also be connected as a 1-phase module according to IEC 255
- Suitable for switchboard mounting on DIN rails.
- Detailed phase failure information and location details in plain text at the emergency lighting central.
- Variable delay time after mains return.

A maximum of 31 DPÜ/B.2 modules can be connected to one controller unit!

Technical data

Housing:	Thermoplastic V0
Nominal voltage:	230V/400V AC 50/60 Hz
Threshold:	0,85 U_N
Protection category:	II
Protection class:	IP20
Perm. temperature range:	-15°C ... +40°C
EMC compatibility:	acc. to EN 61000-6-2 / 61000-6-3
Terminals:	2.5mm ² single-core 1.5mm ² multi-core with ferrule

For voltage monitoring of sub distribution boards
Equipped with one voltage-free fault signal change-over contact

- LED indicator for L1, L2, L3
- Any phase sequence
- Detection of undervoltage and mains failure at three-phase network
- Can also be connected as a 1-phase module acc. to IEC 255, VDE0435, T.303
- Suitable for switchboard mounting on DIN rails

Technical data

Housing:	Thermoplastic V0
Nominal voltage:	230V/400V AC 50/60 Hz
Threshold:	0.85 U_N
Protection category:	II
Protection class:	IP20
Perm. temperature range:	-20°C ... +40°C
EMC compatibility:	acc. to EN 61000-6-2 / 61000-6-3
Terminals:	2.5mm ² single-core 1.5mm ² multi-core with ferrule

DPÜ/B.2

Art. No. 890 417

DIN rail mounting

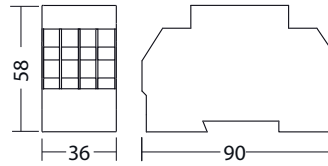

DPÜ

Art. No. 890 400

DIN rail mounting

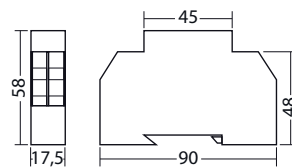

CLS Dimmer

Central dimming module

Enabling central dimming of luminaires connected to different final circuits.

The dimming from 0% (luminaire off) up to 100% in steps of 10% is adjustable by

- the integrated push-buttons
- an externally connected push-button
- or by an external 0-10V control voltage

Perfectly suitable for applications in cinemas, theatres or showrooms.

Technical data

perm. temperature range:	-15°C bis +40°C
Dimension:	H = 58, B = 17,5, T = 90 (mm)
Nominal voltage DC :	24V ± 20%
EMC compatibility:	acc. to EN 55015

CLS Dimmer

Art. No. 850 013

DIN rail mounting

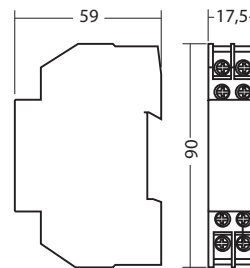

INOLan.2

Network interface for connection of INOTEC emergency lighting devices to the RTG-Bus.

Includes RJ-45 port for connection with an existing Ethernet. Suitable for mounting on DIN rails

Technical data

Material:	Polycarbonate
Nominal voltage:	24V ±10%
Nennverbrauch:	1.7 VA
Terminals:	2.5mm ² single-core 1.5mm ² multi-core with ferrule
Perm. temperature range:	-15°C...+40°C
Protection class:	IP20
Protection category:	III
EMC compatibility:	acc. to EN 55015

INOLan.2

Art. No. 990 253

DIN rail mounting

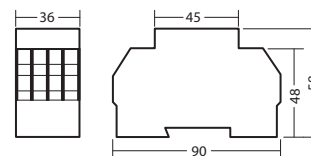

For common switching (On/Off) of general and safety luminaires

The assignment of the luminaires to the light switch application module is done during programming of the controller.

A maximum of 8 LSA3.1 modules can be connected to one controller.

Technical data

Housing:	Thermoplastic V0
Nominal voltage:	230 V AC
Protection category:	II
Protection class:	IP 20
Perm. temperature range:	-15°C ... +40°C
EMC compatibility:	acc. to EN 61000-6-2 / 61000-6-3
Terminals:	2.5mm ² single-core 1.5mm ² multi-core with ferrule

LSA 3.1 / 230V

Art. No. 850 010

DIN rail mounting

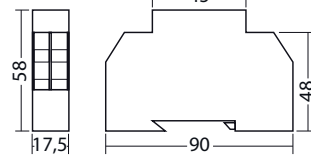

For common switching (On/Off) of general and safety luminaires

The assignment of the luminaires to the light switch application module is done during programming of the controller.

A maximum of 8 LSA3.1 modules can be connected to one controller.

Technical data

Housing:	Thermoplastic V0
Nominal voltage:	24V DC
Protection category:	III
Protection class:	IP 20
Perm. temperature range:	-15°C ... +40°C
EMC compatibility:	acc. to EN 55015
Terminals:	2.5mm ² single-core 1.5mm ² multi-core with ferrule

LSA 3.1 / 24V

Art. No. 850017

DIN rail mounting

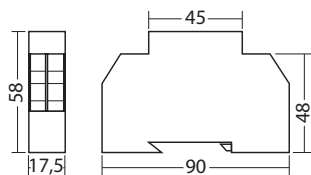

For common switching (On/Off) of mains and safety luminaires and for monitoring of mains voltage.

Channels are galvanically isolated.

The assignment of the luminaires to the light switch application module is done during programming of the controller.

Integrated 3-phase monitoring / BUS:

- Any phase sequence
- Signalling contact / 1 x change-over contact
- Detection of undervoltage and loss of mains
- 1-ph connection possible acc. to IEC 255, VDE 0435, T.303
- Nominal Voltage 230V / 400V AC
- Threshold: 0,85 Un
- Deactivateable

A maximum of 3 LSA8.1 modules can be connected to one controller.

Technical data

Housing:	Thermoplastic V0
Nominal voltage:	230V AC
Protection category:	II
Protection class:	IP20
Perm. temperature range:	-15°C ... +40°C
EMC compatibility:	acc. to EN 61000-6-2 / 61000-6-3
Terminals:	2.5mm ² single-core 1.5mm ² multi-core with ferrule

LSA 8.1 / 230V

Art. No. 850 008

DIN rail mounting

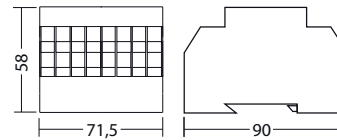

For common switching (On/Off) of mains and safety luminaires and for monitoring of mains voltage.

Channels are galvanically isolated.

The assignment of the luminaires to the light switch application module is done during programming of the controller.

Integrated 3-phase monitoring / BUS:

- Any phase sequence
- Signalling contact / 1 x change-over contact
- Detection of undervoltage and loss of mains
- 1-ph connection possible acc. to IEC 255, VDE 0435, T.303
- Nominal Voltage 230V / 400V AC
- Threshold: 0,85 Un
- Deactivateabl

A maximum of 3 LSA8.1 modules can be connected to one controller.

Technical data

Housing:	Thermoplastic V0
Nominal voltage:	24V DC
Protection category:	II
Protection class:	IP20
Perm. temperature range:	-15°C ... +40°C
EMC compatibility:	acc. to EN 61000-6-2 / 61000-6-3
Terminals:	2.5mm ² single-core 1.5mm ² multi-core with ferrule

LSA 8.1 / 24V

Art. No. 850 007

DIN rail mounting

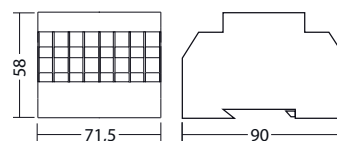

CPS FUSION-MTB

External status and fault indication down to luminaire level of up to 16 connected CPS FUSION systems via three-core RTG bus.

Central initiation of manual and automatic function and duration tests at freely definable time intervals.

The status of the emergency lighting systems is indicated by 3 Status-LEDs and on the OLED graphic display in clear text or acoustically indicated by an integrated buzzer.

Function indicators:

- Green LED – operation
- Yellow LED – Battery operation
- Red LED – Fault (general)

Additional status indication by 4 potential-free contacts::

- Operation
- Battery operation
- Fault
- Free programmable

Terminals for circuit loop in order to block/release the connected emergency lighting systems.

CPS FUSION-MTB

Wall mounting

Art. No. 972 400V

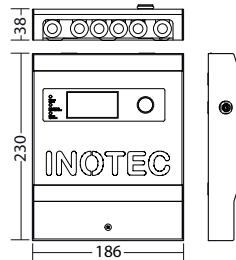

Technical data

Nominal voltage: 230V AC +/- 10%
24V DC +/- 20% (optional)

Perm. temperature range: -5°C bis +30°C

Protection category: I

Protection class: IP 20

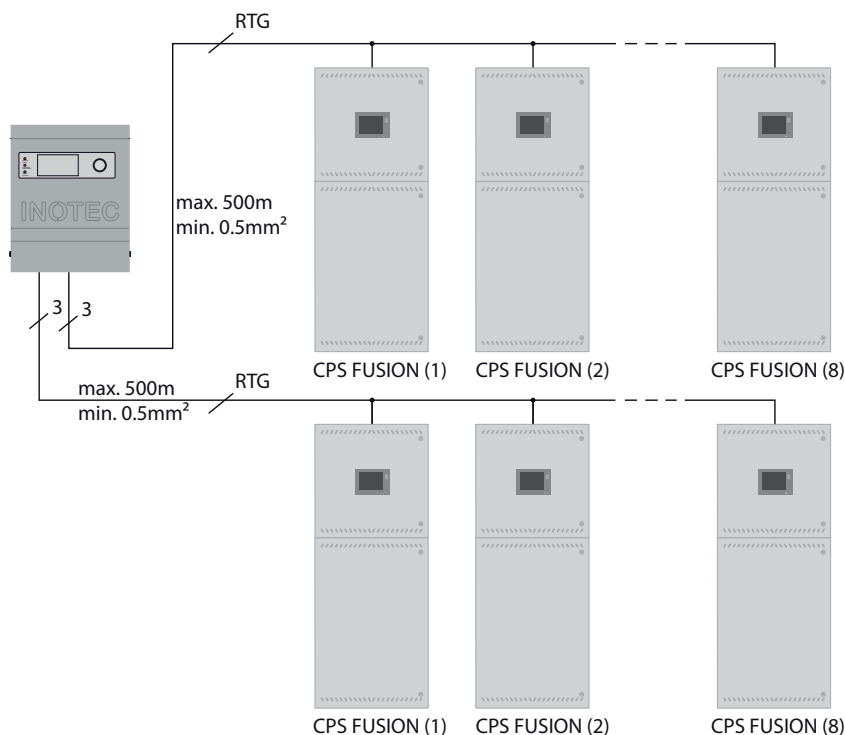

MTB

The MTB-Mimic panels (MTB/AP = wall mounting, MTB/UP = switchboard/recessed wall mounting) are used to display status and fault messages of emergency lighting systems.

With the integrated key-switch, the system can be blocked.

Functions:

Key-switch programmable for

- Emergency and maintained light ON/OFF
- Maintained light ON/OFF

Function indicators:

- Green LED – operation
- Yellow LED – Battery operation
- Red LED – Fault (general)

Connection to relay contacts of a CPS FUSION; maximum wire length with a cross-section of 0.5mm²: 500m

Technical data

Nominal voltage:	U _N = 24V DC +/-10%
Operating mode:	Continuous operation
Perm. temperature range:	-15°C bis +40°C
Protection class:	IP30
Housing:	Stainless steel cover/Polycarbonate
EMC compatibility:	acc. to DIN EN 55015

Logbook

For emergency and safety lighting systems in DIN A4 folder format.

Including templates for commissioning, tests, inspections and maintenance as well as information related to the German regulations, which are currently valid.

The back of folder can be labelled with specific project and system information.

Includes 64 pages and 11 register.

MTB/AP

Art. No. 990 097

Wall mounting

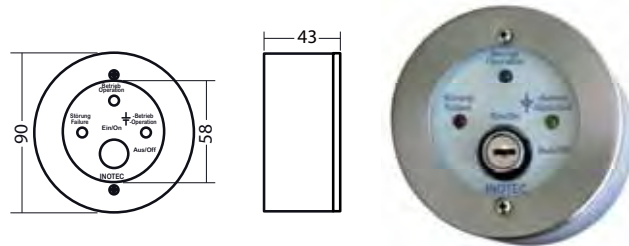

MTB/UP

Art. No. 990 039

Recessed wall mounting

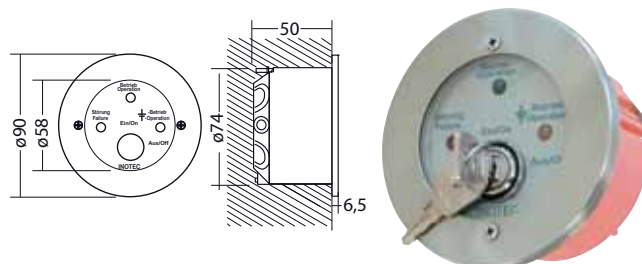

Logbook

Art. No. 708 059

Documentation





INOView - Central Monitoring for Emergency Lighting

INOView is the central visualisation solution for all INOTEC emergency lighting systems. All information on the connected systems can be called up in an intuitive interface. Due to its open architecture and multi-user capability, the software is suitable for all project sizes.

Advantages

- Central logbook
- Detailed fault information down to luminaire level
- Multi-user operation
- Access authorisation
- E-mail Client
- Client-Server-operation
- Floor plan visualisation
- Monitoring of all INOTEC emergency lighting systems

Applications

- Public buildings
- Industry
- Hotels
- Offices
- Meeting places
- Sales premises



INOView - A new perspective

Emergency and safety lighting is used to ensure people's safety in buildings in the event of a power failure or fire. It is essential that the safety equipment is tested, maintained and monitored in accordance with the applicable standards to ensure that this is the case in the event of such an emergency. The results must be recorded accordingly.

The INOView monitoring software from INOTEC supports you to achieve this. A solution that offers a multitude of possibilities, reacts flexibly to the requirements and enables a standard-compliant verification of the system states through the integrated test book.

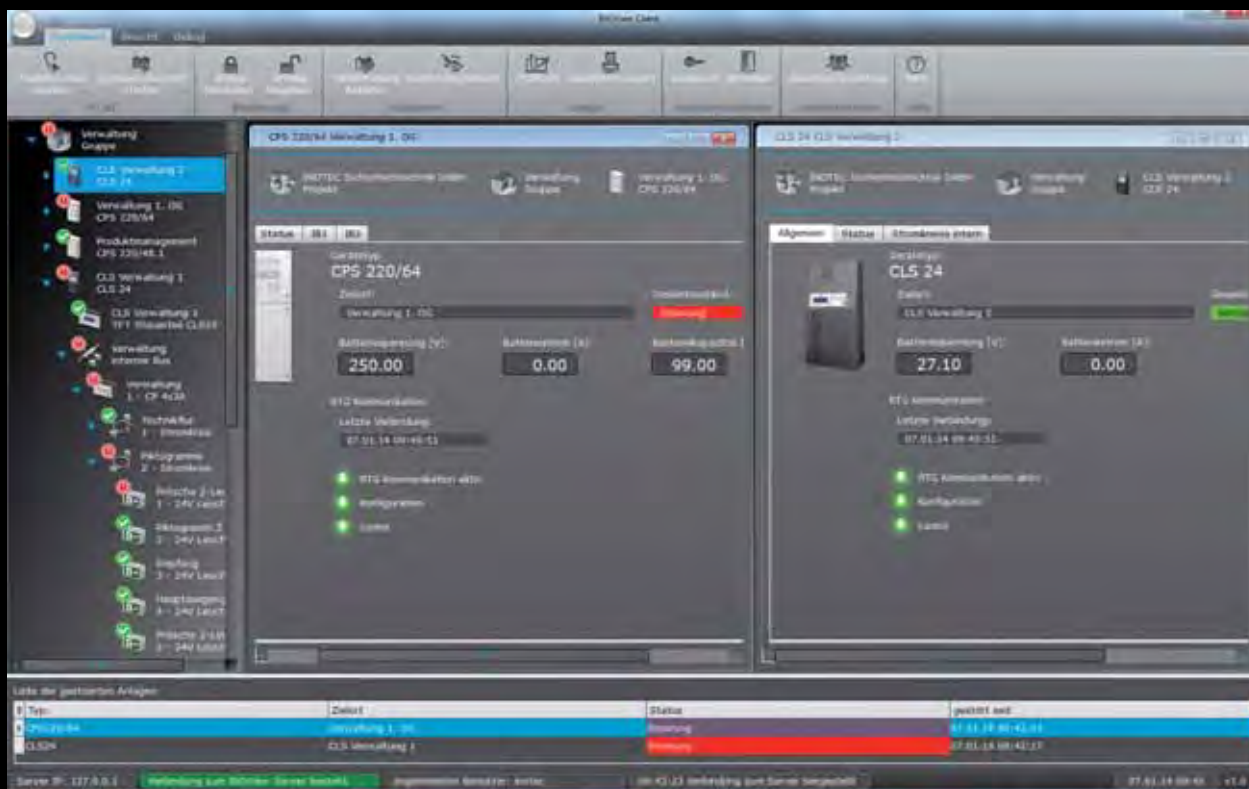

- ▶ Monitoring of INOTEC emergency lighting systems CPS 220/64, CPS 220/48.1, CPS 220/20, CPS 220/48, CLS 24, CLS 24.1, NEA-ICU, NEA, BNS-MTB, LPS24, ELS, CLS FUSION, CPS FUSION, DER 220
- ▶ Connection of the devices via network or/and INOTEC RTG-BUS
- ▶ Failure information down to luminaire level with destination texts
- ▶ Logbook
- ▶ Message window of faulty devices
- ▶ Group functionality
- ▶ Automatic function and duration test programable at project, group and device level
- ▶ Simultaneous display of multiple detail views
- ▶ Multilinguality
- ▶ Access authorisation
- ▶ Multi-user operation
- ▶ Client-Server operation
- ▶ Email notification at status changes
- ▶ Floor plan visualisation

Everything at a glance for personal safety in buildings

The user was in the focus of the development of the visualisation software INOView. It is important to provide simple, intuitive user guidance and transparency through clearly structured system images and clear texts. At just one view, the user recognises the overall status of the safety lighting system and may quickly initiate measures to guarantee personal safety in the building.

The INOView software ensures transparency and provides the user with comprehensive and detailed information about the systems.

Modern Client-/Server – architecture

A modern client/server architecture creates future and investment security. From the clients, several users in the network can simultaneously access the information of the INOView software. An integrated user administration protects the software from unauthorised access.



Adaptive

Every project is structured individually and has different requirements. You can configure the INOView software to meet your requirements and wishes. The integrated grouping option allows you to structure projects according to your preferences. For example, you can define locations, buildings or responsibilities as a group in which you assign the monitored emergency lighting systems.

Automatic tests

With automatic tests, the INOView software simplifies the tests and maintenance required by the standards and thus improves the availability of emergency and safety lighting. You can freely define the tests for each device, group or overall project.

Powerful and easy to use

With the INOView software, you have your emergency lighting systems clearly and safely "under control". Intuitive operating menus enable simple and convenient operation. Individually configurable visualisations of the information ensure transparency. The software grows with the size of the project. Whether a school or an airport, the INOView software is adapted to the customer's requirements with modern standards.

Overview of benefits

- ▶ Easy to use
- ▶ Transparency
- ▶ Adaptable, flexible and expandable
- ▶ Modern software architecture

Installation examples

Client and server components are installed on a PC. The connection of the monitored systems is made via USB or a serial interface for INOTEC RTG-BUS systems or via network connections for devices with a network interface. Access is only from this PC, no network access is provided.

Using the three-core INOTEC RTG-BUS, a free topology with a maximum overall length of up to 500m is possible. The device types can be mixed within one line.

Application examples: Schools, retirement homes, multi-storey car parks, theatres, cinemas, small industrial companies, etc...

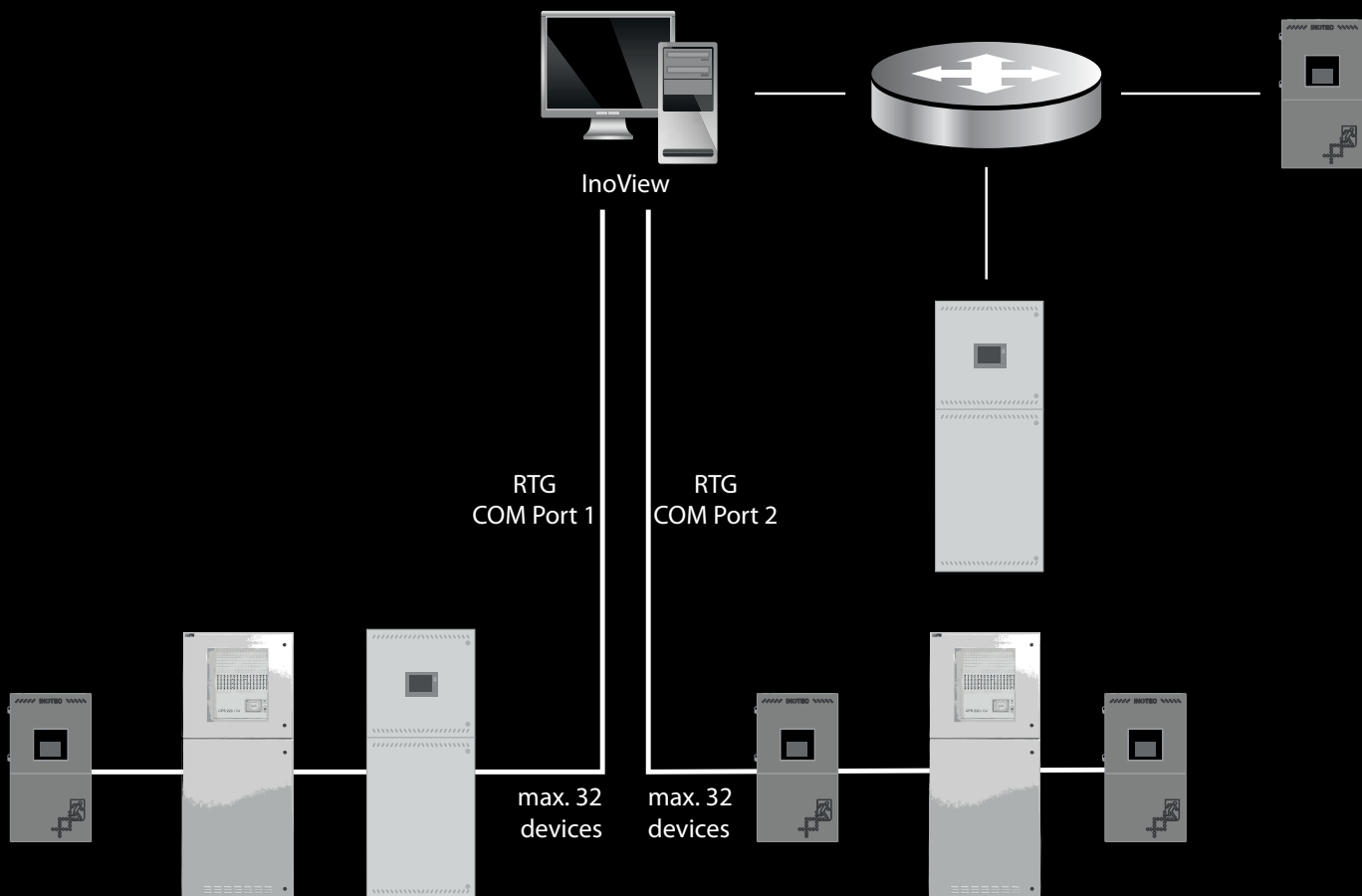

The INOView server is installed on a physical or virtual server, the users get access via client software at their workstation. Several users can work simultaneously with this installation in the network. Several interfaces for monitoring via INOTEC RTG-BUS are connected to the server, further devices are monitored simultaneously by network.

A multi-location monitoring is possible with a company network. This is interesting for industrial or logistics companies with several locations that prefer centralised monitoring, but for example also for the public sector with a central technician who is responsible for several schools.

Using the three-core INOTEC RTG-BUS, a free topology with a maximum overall length of up to 500m is possible. The device types can be mixed within one line.

Application examples: Public sector, clinics, industrial companies, airports, logistics centres, etc.

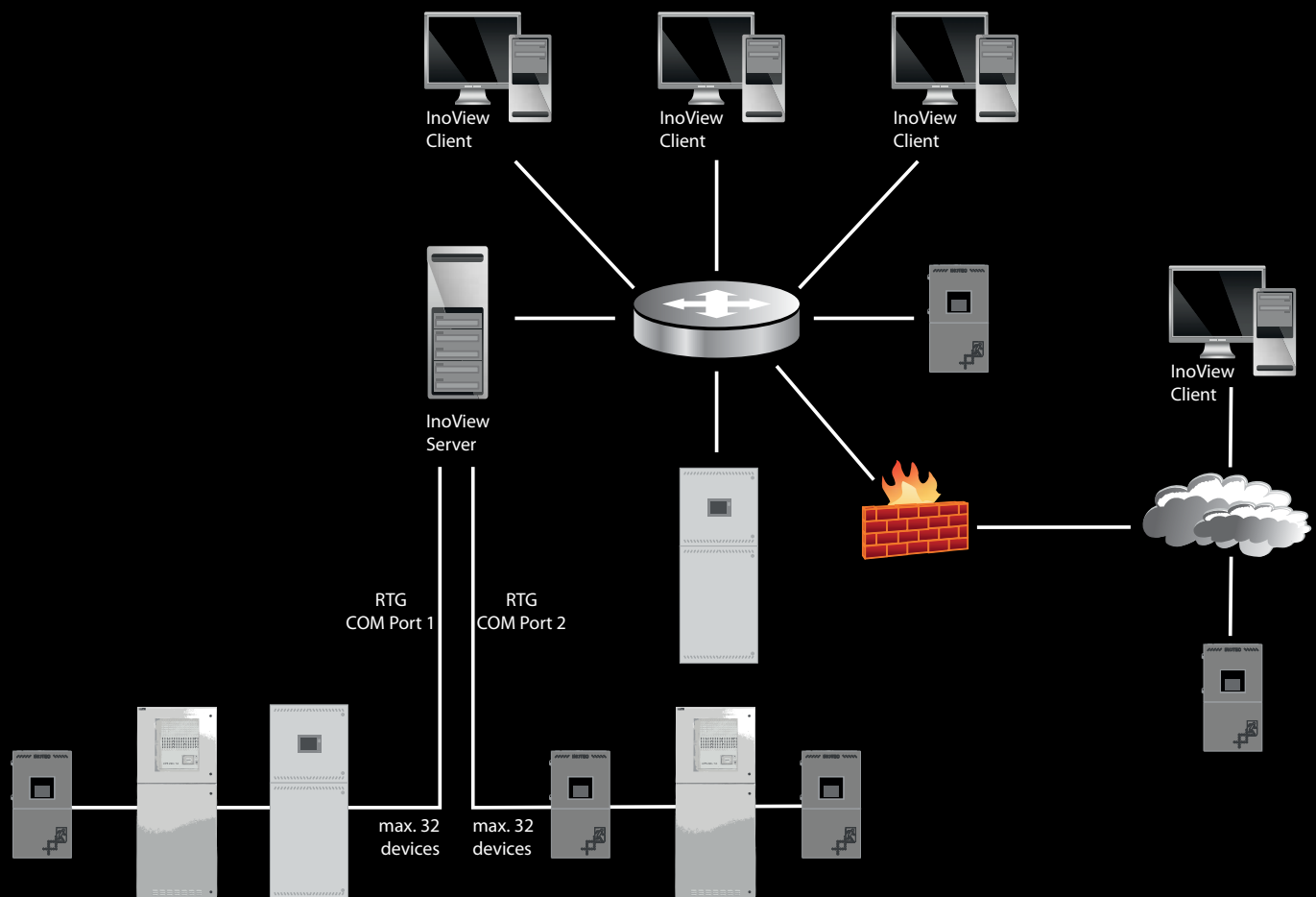

The screenshot shows the INView Client interface. At the top, there is a navigation bar with icons for Logout, User administration, RCS View, Settings, and Help. Below this is a section for 'Special functions' with icons for CUBE Group and CPS FUSION 8. The main area displays 'Total status' as 'Operation' with a green progress bar. Below this are 'status information' and 'Battery capacity [%]' showing '100.00'. A 'Configuration download' button is visible. At the bottom, there is a table of status events.

3 points to the Help icon in the top navigation bar.

4 points to the Configuration download button.

8 points to the CPS FUSION 8 icon in the Special functions section.

9 points to the Total status bar showing 'Operation'.

Status	Faulty since
Blocked	13.06.2019 08:05
1ao failure	12.06.2019 10:22
Failure	12.06.2019 10:22
Offline	12.06.2019 10:22
Offline	12.06.2019 10:22
Failure	13.06.2019 01:00

Floor plan visualisation

To quickly locate defective luminaires, it is possible to visualise them in a floor plan with their status. One floor plan can be stored per circuit. The vector graphics are based on files in Scalable Vector Graphics Format (SVG), which can be exported from common CAD programs.

The luminaires will be imported from the luminaire database by drag & drop, scaled and aligned.

It is also possible to print out the floor plan with the luminaire status.

The module "floor plan visualisation" is optional.



- 1 Position and status of the luminaires.
- 2 Luminaire container for placing into the floor plan
- 3 Faulty emergency luminaire
- 4 Import floor plans
- 5 Printout of the displayed floor plan view

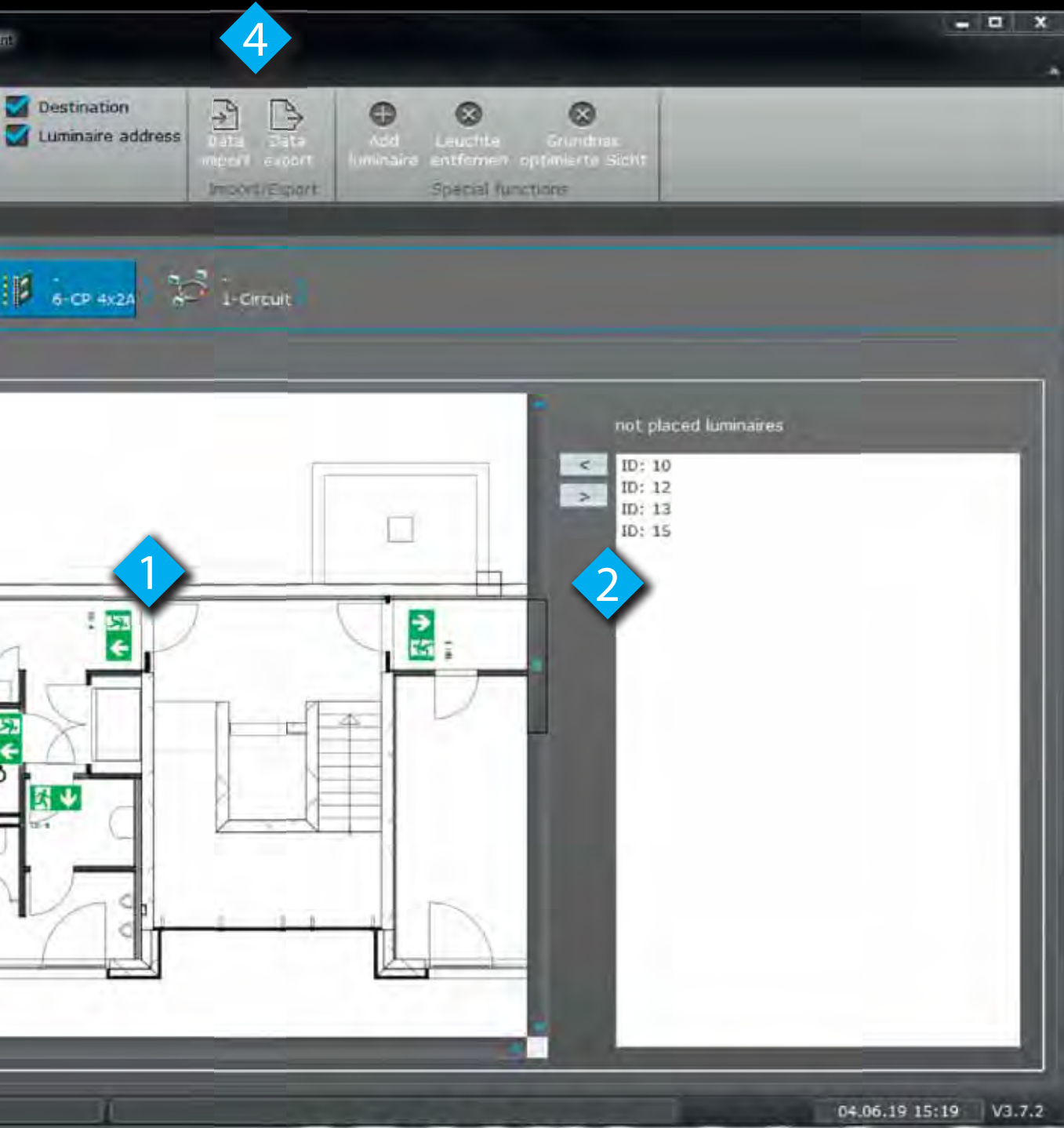

Analysis, log book, fault overview



Simultaneous display of several detail views.



Freely definable table views. Double-click on an entry to navigate to it.



All faults are displayed in the Device faults dialog. A double-click opens the corresponding fault in the detailed view - a quick and easy troubleshooting.



Clear logbook view with filter function. The entries can be filtered freely in the table. Output to a printer is also possible.



The entries in the tables can be grouped or filtered several times using the existing columns. For example, the entries can be grouped by destination of the device and event. Thus a simplified failure analysis is possible.



Further information can be accessed from the detailed view. Individual luminaire faults are displayed with destination information and can be exported to a printer.

INOView Battery monitoring

Mit Integration des Battery Control Systems (BCS) zur Überwachung jedes einzelnen Batterieblocks in die INOView-Software, ist eine genaue Analyse der aufgezeichneten Daten möglich.

Diagrams visualise very clearly the state of the block voltage and temperature of the battery blocks. The BCS system logs the measurement data daily and from each duration test. The BCSView software, which can be accessed directly from the INOView software, is used to display the information.

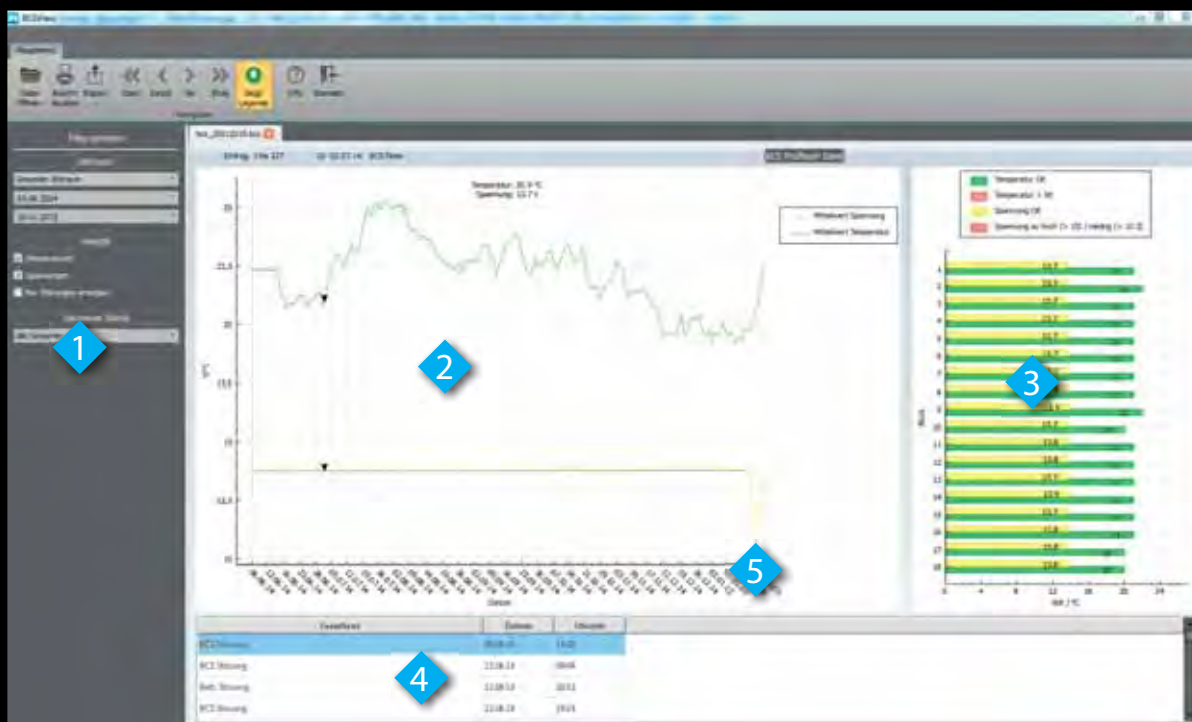

User Interface Overview

- 1 Filter functions
- 2 Battery block temperature / voltage within a time period
- 3 Display of the individual values at a specific period of time
- 4 Table with special events
- 5 Voltage drop of the battery blocks

For use with the INOView software, the supported systems must be connected via a network.

INOView E-Mail notification

The integrated e-mail function automatically notifies recipients in the event of a fault, power failure or after a function test.



The recipients receive an e-mail with the necessary information and can immediately decide how quickly a response is required.



An SMTP server is required for e-mail functionality.

The INOView software also supports e-mail servers with authentication.



It can be defined exactly after which event a notification is sent by e-mail. Alternatively, a mail can be sent daily at a specified time across all devices with an abnormal status.

Everywhere in use

INOView supports you in all aspects of ensuring personal safety and simplifies the maintenance and care of emergency and safety lighting.

Schools & Universities

Every day there are hundreds or even thousands of people in schools and universities. Safety must always be guaranteed during operating hours, making continuous monitoring of emergency and safety lighting necessary. Since these complexes usually extend over several buildings, a central administration optimises the tasks of the technician using INOView software.

In order to prevent battery discharge during downtimes and to reduce operating costs, the emergency lighting systems can be blocked centrally and corresponding areas can be reactivated for evening events.

Transport & Traffic

Whether airports or railway stations, there are a large number of travellers around the clock. A panic can quickly break out in the event of danger or an emergency. Emergency and safety lighting must function to ensure that people can leave the building safely.

In such objects there are several thousand light points, a central control and maintenance point must keep the overview. INOView shows its strength with its clear structure especially in such projects. The individual grouping options and a clear overview of the existing faults with filter options support you in your daily work.

Public buildings, theatres & meeting places

Non-local people stay in public buildings, theatres and meeting places every day. In an emergency, these people must immediately recognise how to leave the buildings safely.

INOView is your tool to simplify the maintenance and care of emergency and safety lighting and ensure safety in the building.

Logistics & Industry

A central electrical service centre has to take care of the maintenance of several buildings and sites in the logistics and industrial sector. This requires a lot of time. The central monitoring system INOView supports you with important information and clearly structured messages to reduce your workload. Building complexes or locations can be usefully combined using the freely definable groups. Regardless of the device type, you can see in which area a fault is present.



Visualisation software INOView, for centralised remote monitoring of INOTEC emergency lighting systems. The client-/server- architecture allows access of multiple PCs within the network. The essential version of INOView includes logbook, failure information, automatic tests and 10 system credits for INOTEC emergency lighting systems.

System requirements

Server:

- Operating system: Microsoft Windows 7, Windows 2008 Server, Windows 2012 Server, Windows 10
- Processor: Intel or AMD
- Memory (RAM): min. 2GB
- Interfaces: USB*, maybe RS 232
- Network: TCP/IP

Client:

- Operating system: Microsoft Windows 7, Microsoft Windows 8, Windows 10
- Processor: Intel or AMD
- Memory : min. 2GB
- Network: TCP/IP

* Required for USB-Dongle

The INOView system credits upgrade is available to monitor additional INOTEC emergency lighting systems. It's possible to purchase single system credits.

INOView licensing

The INOView software has to be licensed according to the amount of monitored INOTEC emergency lighting systems. The amount of needed system credits depends on the different device types.

Device type	System credits per device
CPS 220/64, CPUS 220/64, CPS 220/48.1, CPUS 220/48.1, CPS 220/48, CPUS 220/48 CPS 220/20 CPS FUSION DER 220	3
CLS 24/CLS 24.1, CLS 24-7Ah, CLS FUSION	1
NEA, LPS 24, BNS-MTB, NEA-ICU, ELS	2

INOView – Essential software package

Art. No. 185 405



INOView software - basic version with soft dongle

Art. No. 185 412



INOView – system credits upgrade

Art. No. 185 406



INOView floor plan upgrade

Art. No. 185 413



Standard network interface to INOTEC RTG-BUS for connection of INOTEC emergency lighting systems. RJ45 interface for connection to existing ethernet. Suitable for DIN-rail mounting.

Technical data

- Material:** Polycarbonate
- Nominal voltage:** 24V ±10%
- Power consumption:** 1.7 VA
- Terminals:** 2.5mm² single-core
1.5mm² multi-core with ferrule
- Perm. temperature range:** -15°C...+40°C
- Protection category:** IP20
- Protection class:** III
- Acc. to DIN EN 55015
- Mounting:** DIN rail mounting

RTG interface for connection of up to 32 INOTEC emergency lighting systems to a PC via USB- or serial RS232- interface. Included in delivery:
1x Power supply
1x Connection cable 1m
1x Driver-CD for RTG – Interface (USB)

Technical data

- Material:** Polycarbonate
- Nominal voltage:** 230V ±10%, 50/60Hz
- Terminals:** 2.5mm²
- Perm. temperature range:** -15°C...+40°C
- Protection category:** IP20
- Protection class:** II/III
- Acc. to DIN EN 55015

INOLan.2

Art. No. 990 253

Data interface

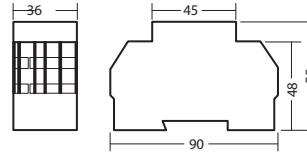

RTG - Interface (USB)

Art. No. 851 045

Data interface

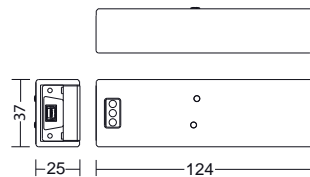

RTG - Interface (RS 232)

Art. No. 851 044

Data interface

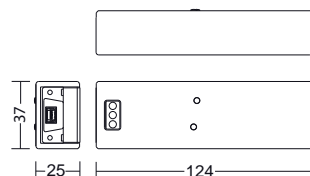

Dongle Device Server for integration into a virtual network environment. This component is needed, if the INOView server is installed on a virtual machine. The integration is done by network connection and a software within the virtual machine.

System requirements

Operating systems: 32/64-Bit: Windows XP, Windows 7, Windows 10, Windows Server 2008, Windows Server 2012

Network interfaces: 10BaseT/100BaseTX/1000BaseT

Interfaces: 2xUSB 2.0

INOView ZLT-Interface to communicate fault reports to the existing BMS. Suitable to connect to a remote switch as well as to loop monitoring. Five potential free contacts programmable for operation, failure (general) and 2 freely. Installed in distribution board, incl. power supply (146030)

Technical data

Material: Polycarbonate

Nominal voltage: 230 V ± 10%, 50/60 Hz

Terminals: 2.5 mm²

Perm. temperature range: -15 °C ... +40 °C

Protection category: IP30

Protection class: III

Acc. to to DIN EN 55015

The IB-Interface is a communication interface between INOView(180405) and ZLT-Interface(990227).
Included in delivery:
1x Power supply
1x Connection cable 1m
1x Driver - CD

Technical data

Material: Polycarbonate

Nominal voltage: 230 V ±10%, 50/60Hz

Terminals: 2.5 mm²

Perm. temperature range: -15 °C ... +40 °C

Protection category: IP20

Protection class: II/III

Acc. to DIN EN 55015

Dongle Device Server

optional accessory

Art. No. 185 050



INOView ZLT-Interface

optional accessory

Art. No. 990 227



IB-Interface (USB)

optional accessory

Art. No. 851 049

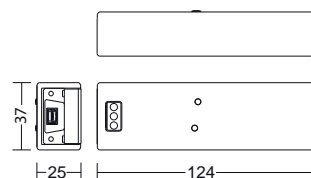

Regulations and Standards

What you need to know about emergency luminaires and exit signs

The following pages list the regulations and standards that apply to safety and emergency exit luminaires. These can be divided into lighting and electrical standards.



Lighting standards

EN 1838	Lighting applications. Emergency lighting
DIN 4844-1 / ISO3864	Graphical symbols - Safety colours and safety signs
DIN 4844-2	Graphical symbols - Safety colours and safety signs
DIN 4844-3	Graphical symbols - Safety colours and safety signs
ASR A1.3	Health and safety signs
ISO 7010	Graphical symbols – Safety colours and safety signs

Electrical standards

EN 60598-1	Luminaires – Part 1: General requirements and tests
EN 60598-2-22	Luminaires – Part 2-22: Particular requirements – Luminaires for emergency lighting
EN 55015	Limits and methods of measurement of radio disturbance characteristics of electrical lighting and similar equipment

Lighting requirements for escape-routes according to EN 1838

When the emergency lighting is in operation, the luminance of the safety colour must be at least 2 cd/m^2 at every point of the sign.

The colours must meet the requirements of ISO 3864.

A lamp's colour-rendering index, R_a , must be equal to at least 40.

The ratio of the luminance L_{contrast} to the luminance L_{safety} colour must be no less than 5:1 and no more than 15:1.

The ratio of the maximum luminance to the minimum luminance must not exceed 10:1 either within the white surface or within the safety colour.

Safety and exit sign luminaires have to be illuminated or by an internal or external illuminant. Fluorescent signs aren't allowed.

The light requirements of the standard are minimum values that also have to be achieved at the end of life of every component.

The planning of emergency light must be based on the worst environmental conditions for the entire expected lifetime (e.g. highest glare, minimum luminous flux (self-contained luminaires, light output reduced ballasts)).

For direct illuminating luminaires only the direct light has to be considered. Reflected light of surrounding walls must be neglected.

For indirect illuminating luminaires and ceiling floodlight, always working with a reflecting surface, only the first reflection must be considered.

If possible safety signs shouldn't be mounted higher than 20° above the horizontal viewing line with respect to the maximum viewing distance.

Example: Viewing person 2m tall

EW 20m $\rightarrow h_{\text{max}} = 9.2\text{m}$

EW 35m $\rightarrow h_{\text{max}} = 14.7\text{m}$

Viewing distance according to EN 1838 10/2013 and DIN 4844-1

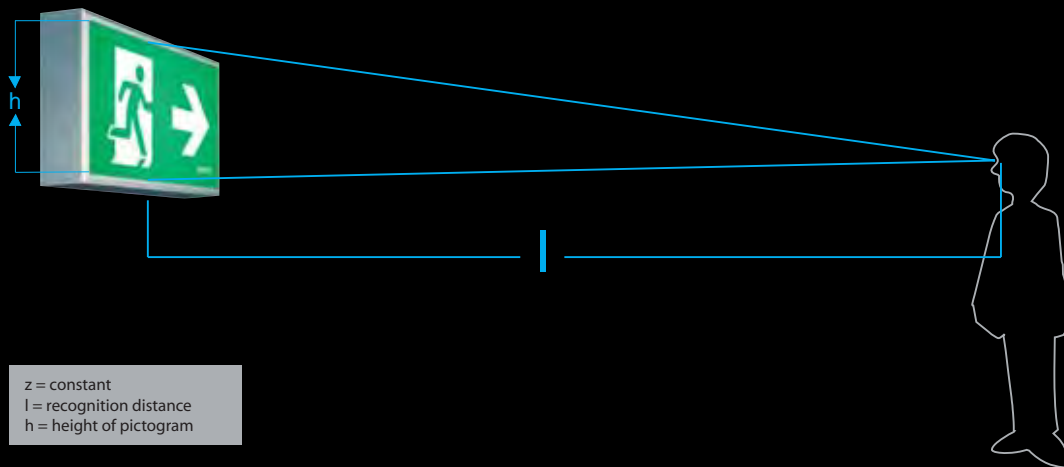

Calculation formula: $l = z \cdot h$

$z = 100$ - for illuminated signs, but only when the illuminance on the surface of the sign is $E \geq 50 \text{ lx}$.

$z = 200$ - for backlit signs (pictogram luminaires), but only when the luminance is $L \geq 500 \text{ cd/m}^2$ in mains operation.

Rule of thumb:

Pictogram signs need to be twice as large as pictogram luminaires at the same recognition distance.

Note:

With the luminance $L=500 \text{ cd/m}^2$ given above, the pictogram should be sufficiently recognisable in bright surroundings. In order to avoid glare effects, the luminance needs to be reduced in dark surroundings, for instance by the use of INOTEC pictogram luminaires with adjustable light output in monitored LED technology.

Emergency signs according to ISO 7010

Examples



The arrows may only be used in conjunction with an additional exit pictogram and vice-versa.

The arrows may be rotated in 45° increments.

In combination signs, the light edges between the pictograms may be omitted.

Emergency lighting for escape routes

For escape routes with a width of up to 2m, the horizontal illuminance on the floor along the central line of the escape route must be no less than 1lx, and the central area, corresponding to no less than half the width of the escape route, must be illuminated with at least 50% of this value.

The ratio of the maximum illuminance to the minimum illuminance must not exceed 40:1 along the central line of the escape route.

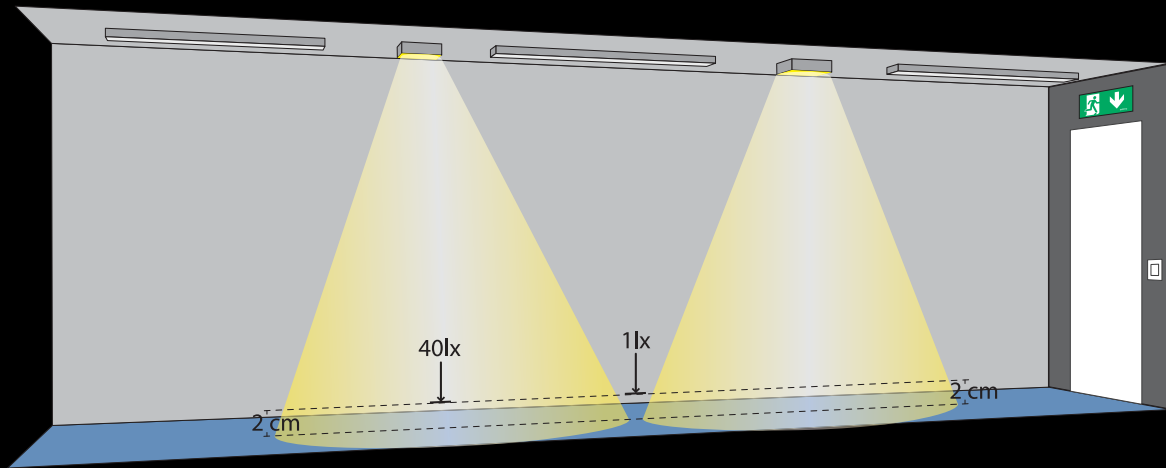

Type of lighting	Required illuminance	Uniformity (E_{min}/E_{max})
Safety lighting for escape routes:	1 lux (*2) along the central line of the emergency route	1:40
Safety lighting for hazardous areas:	10% of general lighting, minimum 15 lux (*2)	1:10
Open space lighting:	Minimum 0.5 lux (*2) on the free floor surface	1:40

Type of lighting	Rated operating time	Response time (*1)
Safety lighting for escape routes:	At least 1 hour	50% of E_{min} within 5 seconds, 100% within 60s (for German workplaces, 100% within 15s)
Safety lighting for hazardous areas:	The rated operating time must correspond to the length of time for which danger exists for humans	The required illuminance must be permanently present or achieved within 0.5 seconds
Anti-panic lighting:	At least 1 hour	50% of E_{min} within 5 seconds, 100% within 60 seconds

(*1) Interval between failure of the general lighting and achievement of required illumination level by the emergency lighting

(*2) Measurement plane $\leq 2\text{cm}$ above the floor.

Physiological glare

Physiological glare must be kept low by limiting the luminosity of the luminaires within the field of vision.

For escape routes that run horizontally, the luminosity within an area of 60° to 90° to the vertical must not exceed the values in the table for all azimuth angles. For all other escape routes and open areas, the limits must not be exceeded for any angle.

Limits for physiological glare

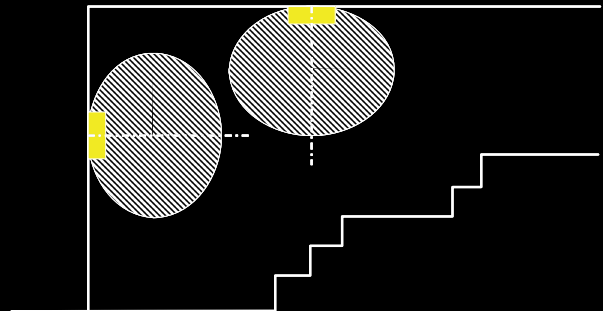
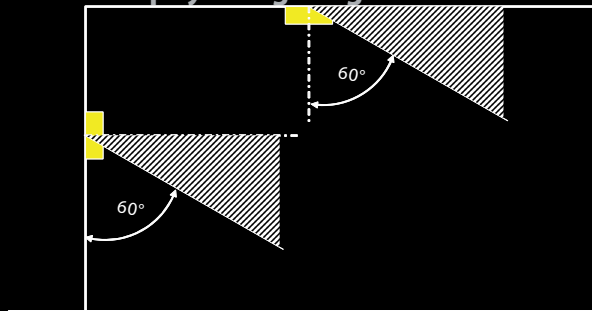

Mounting height above the ground h	Maximum luminosity for escape route and open area emergency lighting I_{max}	Maximum luminosity for safety lighting for hazardous areas I_{max}
m	cd	cd
$h < 2.5$	500	1000
$2.5 \leq h < 3.0$	900	1800
$3.0 \leq h < 3.5$	1600	3200
$3.5 \leq h < 4.0$	2500	5000
$4.0 \leq h < 4.5$	3500	7000
$h \geq 4.5$	5000	10000

Spots to be highlighted according to EN 1838



at least 2m above the ground

at each exit door which can be used in emergency



close to (*1) each first-aid station (*2)

close to (*1) any firefighting or alarm device

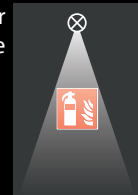

Safety signs and directional emergency escape route signs have to be illuminated or backlit in emergency mode. Photoluminescent signs are not allowed.



close to (*1) evacuation devices for handicapped people

close to (*1) stairs, in order to illuminate each step directly



close to (*1) safe areas for handicapped people and intercoms for these as well as alarm devices for disabled toilets



close to (*1) any level change within the escape route



anti-panic lighting in disabled toilets

at each change of direction

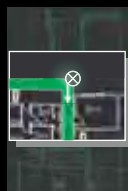

anti-panic lighting on paths to areas where safety lighting is required, but not directly adjacent to an escape route

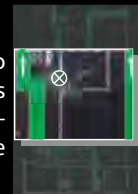

at each intersection of corridors / passages



outside and close to (*1) every emergency exit door up to a safe area

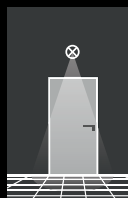

*1 max. 2m horizontal distance
*2 vertical illuminance 5lx

Electrical standards

The electrical standards are taken into account in INOTEC's own construction and development and monitored by our quality control. We guarantee that all INOTEC luminaires comply with the current standards and regulations. You can find the corresponding declarations of conformity on our homepage.

Special colours

The choice is yours ...

If an INOTEC luminaire needs to be colour-matched to customer requirements, INOTEC offers two options: the standard powder coating or the INOTEC high-performance powder coating system.

All luminaires which are used indoors without special stress (IP 4x) can be painted with the standard powder coating. By selecting the appropriate RAL colour, the luminaires can be customised to suit the architecture and colour scheme of the building.

If luminaires with a high degree of protection are required, the INOTEC high-performance powder coating system is used. This coating is a 2-layer powder coating with excellent corrosion protection. INOTEC luminaires with the high-performance powder coating system are ideal for use in rough environments - in- and outdoor. These luminaires can be used in industrial plants, swimming pools or facades without any problems.

Even under strong weather conditions, such as sunlight, temperature and humidity, there is no change in the surface or optical reduction for years. Even aggressive liquids do not damage the high-performance powder coating. By pre-treating the surfaces accordingly, even scratches in the powder coating cannot be infiltrated by rust.



Environmentally friendly and economical

Coatings without solvent emission? Powder coatings make it possible! Powder coatings do not produce any solvent emissions compared to wet coating processes. Therefore the INOTEC powder coatings comply with the EU directives* regarding VOC**. In addition, there are numerous other environmentally relevant advantages of powder coating systems: No waste water is generated during processing, and due to a very high application efficiency (up to 98 %), the amount of waste generated during powder coating processing is very low.

* Ratified in Germany under 31. BImSchV

** The abbreviation VOC (Volatile Organic Compounds) refers to the group of volatile organic compounds (e.g. solvents).

Lighting technology

Measures and units of light

Luminous flux Φ (lumen)

The luminous flux measures the total light output emitted in a spherical radius by the illuminant. It is adjusted to reflect the varying sensitivity of the human eye to different light wavelengths.

The luminous flux is indicated in lumen (lm).

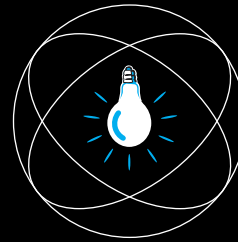

Illuminance E (lux)

Illuminance is a deciding factor in our visual performance. Illuminance therefore has a major influence on how quickly and safely people can leave a building in an emergency.

Illuminance indicates the relationship of the luminous flux falling perpendicularly on a surface to the illuminated surface. Under EN 1838, the minimum illuminance is 1 lux, measured on the central line of the escape route. The maintenance factor must also be taken into consideration. For our spacing tables, we base our calculations on a maintenance factor of 0.8, producing a minimum illuminance of 1.25 lux.

Illuminance is measured with a lux meter at a height of 2cm above the ground.

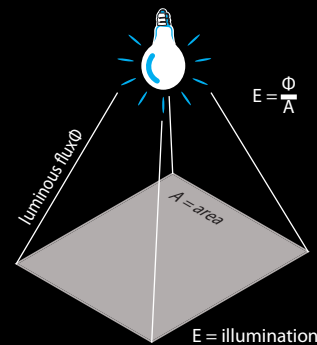

Luminance L (candela / m²)

Luminance is the luminous intensity of a surface. The surface can produce the light itself, or be backlit or illuminated.

In accordance with DIN prEN 1838, the luminance of the safety colour must be at least 2 cd/m² at every point of the sign, from every relevant viewing direction.

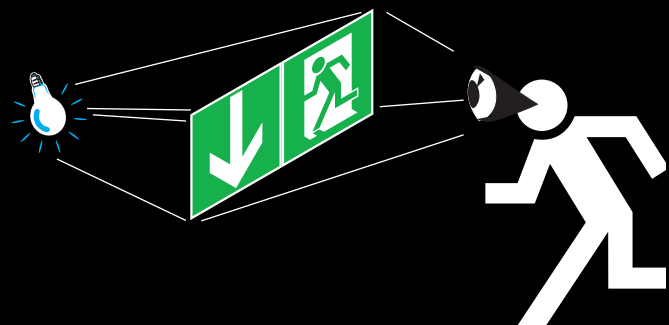

Some facts about LEDs

INOTEC has many years of experience working with LEDs. Thanks to ongoing developments, LEDs offer countless new possibilities in luminaire design.

How a LED works

LED is the abbreviation of **L**ight **E**mitting **D**iode. A LED is a semiconductor diode that emits light when operated in the conducting direction (anode [+] -> cathode [-]). The light's wavelength essentially depends on the semiconductor material used and on its doping. Nowadays, LEDs can reach a luminous flux of more than 120lm/watt. These figures are manufacturer's specifications, measured under laboratory conditions (25°C chip temperature and a current of 350mA).

Service life

The LEDs used by INOTEC have an average service life of approx. 50,000h. To achieve this service life, good thermal management is required, as a LED's service life essentially depends on the temperature and the current flowing through it.

LEDs and PCBs

INOTEC emergency exit and safety luminaires use PCBs (printed circuit boards) that have been specially developed for luminaires, fitted with SMD (surface mount) LEDs. This means that the LED can be perfectly matched to the luminaire design. Secondary optics are used to optimise the light distribution of the LED illuminant for the various areas of application.

LED power supplies

The LEDs are operated with INOTEC constant current power supplies. PSUs with different performance classes were developed for the various application areas, suitable for connection to central and low power supply systems under DIN VDE 0108 and EN 50171. Depending on the version, the LED PSUs also come with integrated Joker technology and individual lamp monitoring. Furthermore, the luminaires can be dimmed in mains operation and automatically switch to 100% in emergency operation.



Contents

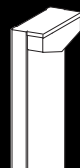

SN 6307



SN 6206-11

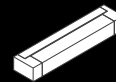

SN 6205



SN(P) 2004.1



SN 6204.2



SN 8106-11



SN 8040



FL 6110



FL 828



SNP 1530.1

SNP 1520.1

Straight-Line
Meeting the highest demands



SNP 1216

SNP 1214

Edge lights
Highlighting modern internal architecture



SNP 7168.1 UP

SNP 7188/7288

SNP 7186/7286

SNP 7184/7284

Aluminium luminaires
The all-rounder



SNP 2435

SNP 2420

Four-sided exit luminaires
with a pictogram ratio of 2:1



SN 6203.1

SN 6124

SN 6114

SN 6110

SN 6109

Wall and step luminaires
Safety and orientation luminaires



SN 804.1 WT

SN 804.1

SN 828

SNP 808

Stainless steel luminaires
Robust luminaires with a high protection rating



SN 8500

SN 8424

SN 9424

SN 9100 TES

SN 9024

Downlights
Powerful and variable



SN 8030

SNP 8030

Ball- and impact resistant luminaires
Ideal for use in sports facilities



SN 2100 ECO

SN 2100

SNP 2230

SNP 2130

Moulded plastic luminaires
Universal emergency exit and safety luminaires



FL 808

FL 7288

FL 7188

FL 1530

FL 1520

Segmental luminaires
Versatile D.E.R. luminaires



EX 7000

EX luminaires
Explosion-proof emergency exit and safety luminaires





Straight-Line

Meeting the highest demands



Besides the high quality and ease of installation, the INOTEC emergency exit sign luminaires of the "Straight-Line" series suit perfectly to modern architectures. The luminaires impress with their slim design and homogeneous illumination. Thanks to their high luminance > 500cd/m², these luminaires are ideally suited for use in bright environments and thus meet the requirements of DIN 4844-1.

Advantages

- State-of-the-art lighting technology
- High quality materials
- Attractive design
- Easy installation
- Easily exchangeable legend panel

Applications

- Public buildings with elegant room architecture
- Offices
- Commercial properties
- Theater
- Shop premises
- VIP-areas
- Hotels
- etc.

	SNP 1520.1	79
	SNP 1530.1	85





Straight-Line high quality emergency exit luminaires, made of powder coated aluminium profile of just 14.5mm thickness. Slim design and brilliant illumination by cutting-edge fibre optics technology with a luminance of >500cd/m².

Technical data

Viewing distance:	20 m	Nominal current DC:	70 mA
Material:	Aluminium powder-coated	Protection class:	III
Illuminant:	LEDs	Input terminals:	2.5mm ² feed through wiring
Nominal voltage DC:	24 V ±20 %	Temperature ta:	-15...+40 °C

Available colours Add colour code to the article no. e.g. 800 014 LXX

RAL 7015 (Slate grey): **L16** ■ RAL 9016 (Traffic white): **L04** □ Special colour: **L99** 🌈

Articles

SNP 1520.1 D / WA LED 24V

Art. no. 810 241

Wall bracket or ceiling mounting

Protection category: IP40

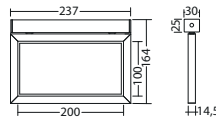

SNP 1520.1 E LED 24V

Art. no. 810 245

Recessed ceiling mounting

Protection category: IP40

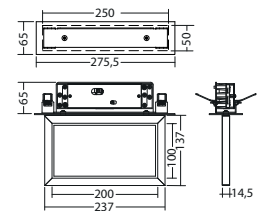

SNP 1520.1 ES LED 24V

Art. no. 810 246

Recessed cable suspension

Protection category: IP40

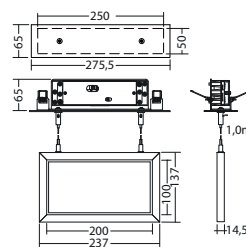

SNP 1520.1 P LED 24V

Art. no. 810 243

Pendulum mounting

Protection category: IP40

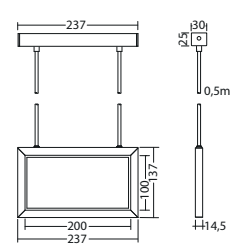

SNP 1520.1 PM LED 24V

Art. no. 810 240

Parallel wall mounting

Protection category: IP40

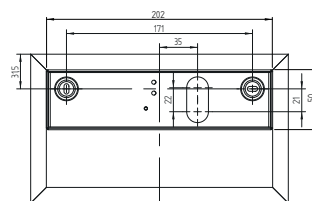

SNP 1520.1 S LED 24V

Art. no. 810 242

Cable suspension mounting

Protection category: IP40

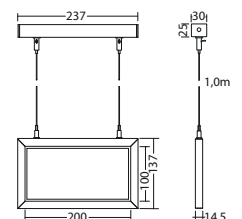

Quality and efficiency

High quality materials

The INOTEC Straight-Line, made of high-quality aluminium profiles, impresses with a flat design and homogeneous illumination.

Due to their high luminance $> 500\text{cd/m}^2$, these luminaires are ideally suited for use in bright environments and thus meet the requirements of the standard.

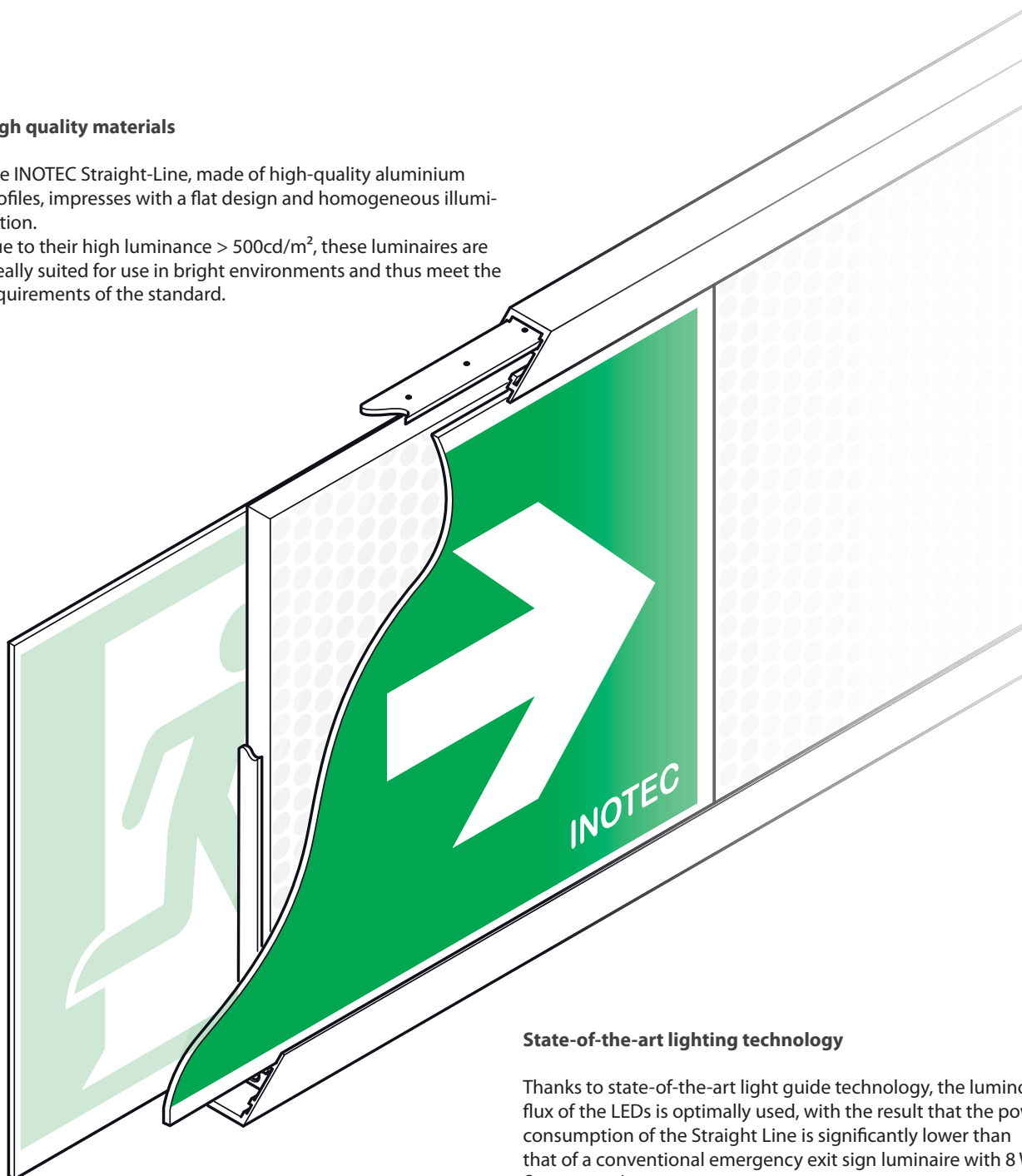

State-of-the-art lighting technology

Thanks to state-of-the-art light guide technology, the luminous flux of the LEDs is optimally used, with the result that the power consumption of the Straight Line is significantly lower than that of a conventional emergency exit sign luminaire with 8 W fluorescent lamp.

A screened light guide panel inside the luminaire ensures uniform and bright illumination of the pictogram panels.

This system also makes it possible to change the pictogram screens easily and without tools.

SNP 1520.1 WE LED 24V

Art. no. 810 244

Recessed wall mounting

Protection category: IP40

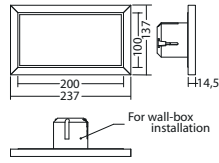









Straight-Line high quality emergency exit luminaires, made of powder coated aluminium profile of just 14.5mm thickness. Slim design and brilliant illumination by cutting-edge fibre optics technology with a luminance of $>500\text{cd/m}^2$.

Technical data

Viewing distance:	30 m	Nominal current DC:	100 mA
Material:	Aluminium powder-coated	Protection class:	III
Illuminant:	LEDs	Input terminals:	2.5mm ² feed through wiring
Nominal voltage DC:	24 V \pm 20 %	Temperature ta:	-15...+40 °C

Available colours Add colour code to the article no. e.g. 800 014 LXX

RAL 7015 (Slate grey): **L16** ■

RAL 9016 (Traffic white): **L04** □

Special colour: **L99** 🌈

Articles

SNP 1530.1 D / WA LED 24V

Art. no. 810 251

Wall bracket or ceiling mounting

Protection category: IP40

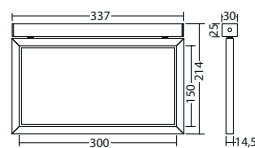

SNP 1530.1 E LED 24V

Art. no. 810 255

Recessed ceiling mounting

Protection category: IP40

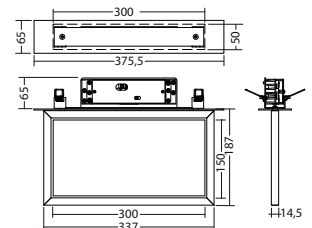

SNP 1530.1 ES LED 24V

Art. no. 810 256

Recessed cable suspension

Protection category: IP40

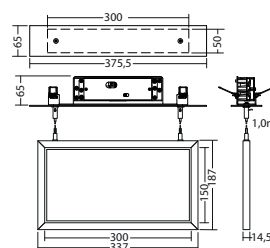

SNP 1530.1 P LED 24V

Art. no. 810 253

Pendulum mounting

Protection category: IP40

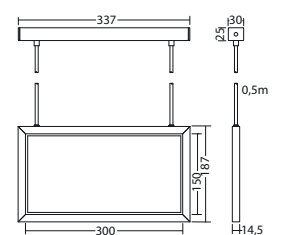

SNP 1530.1 PM LED 24V

Art. no. 810 250

Parallel wall mounting

Protection category: IP40

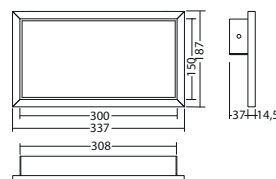

SNP 1530.1 S LED 24V

Art. no. 810 252

Cable suspension mounting

Protection category: IP40

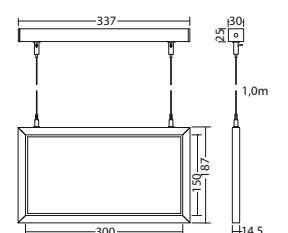

Versatile and ergonomic

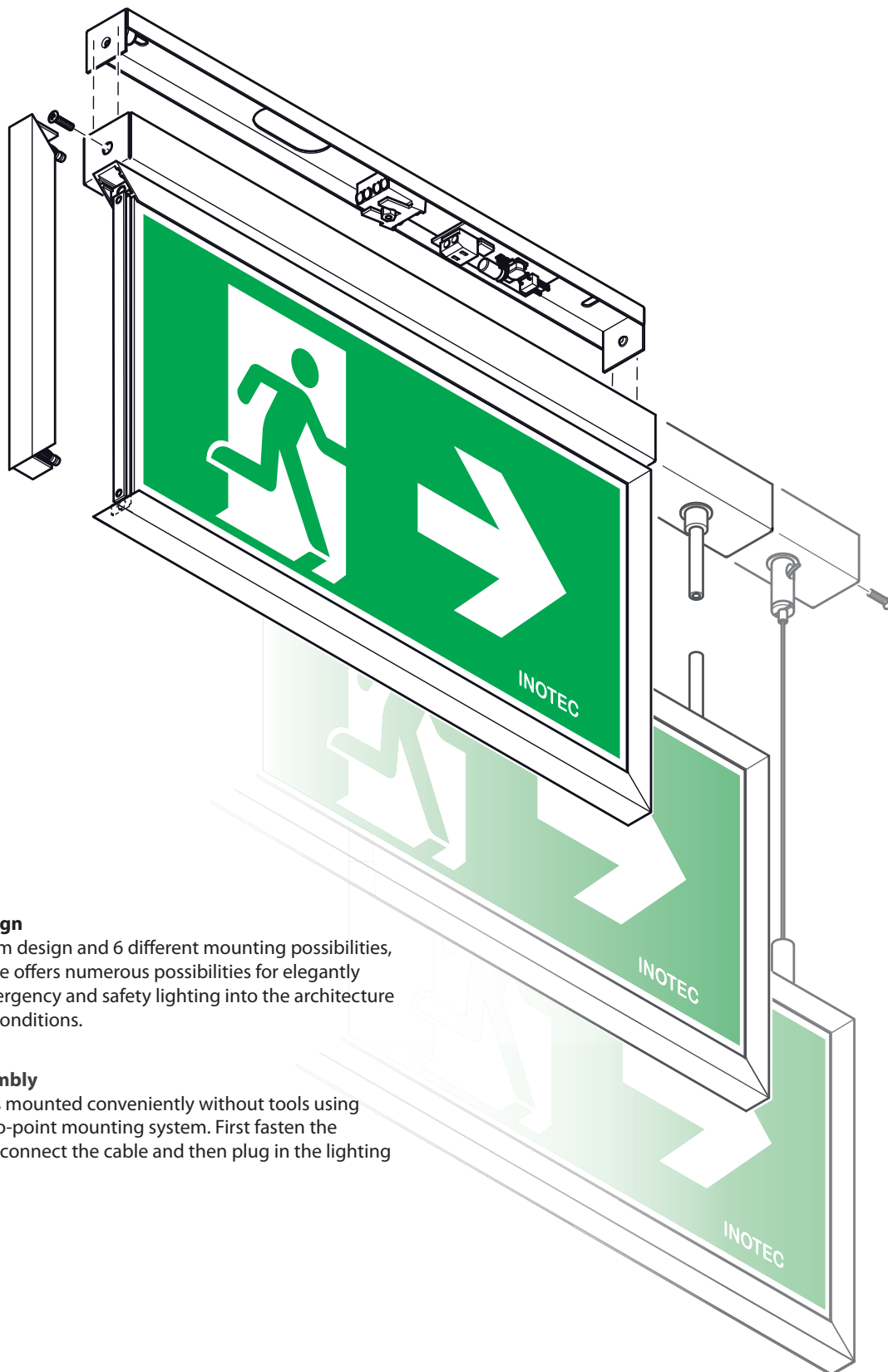

Attractive design

Thanks to its slim design and 6 different mounting possibilities, the Straight-Line offers numerous possibilities for elegantly integrating emergency and safety lighting into the architecture and structural conditions.

Tool-free assembly

The luminaire is mounted conveniently without tools using a pluggable two-point mounting system. First fasten the mounting unit, connect the cable and then plug in the lighting module.

SNP 1530.1 WE LED 24V

Art. no. 810 254

Recessed wall mounting

Protection category: IP40

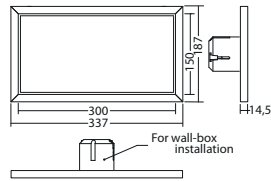





Edge lights

The highlight of modern room architecture

The INOTEC edge lights with freely suspended pictogram screens offer more than perfect safety technology, they set clear accents.

With trend-setting technologies and premium materials in elegant design, the luminaires set standards in functionality, flexibility and standard-compliant illumination.

Advantages

- Attractive design
- Easily exchangeable legend panel
- Tool-free opening

Applications

- Public buildings with elegant room architecture
- Offices
- Shop premises
- Conference facilities
- VIP-areas
- Hotels
- etc.



SNP 1214

92



SNP 1216

93



SNP 1214 WA scale 1:1

Discreet solution with 24V technology

The elegant 24V edge lights are made of high-quality aluminium profile and characterised by their slim, discreet design. A 20mm thick acrylic glass screen offers a homogeneous and bright illumination of the pictogram. Thanks to their versatile mounting options, the luminaires are flexible in their application.

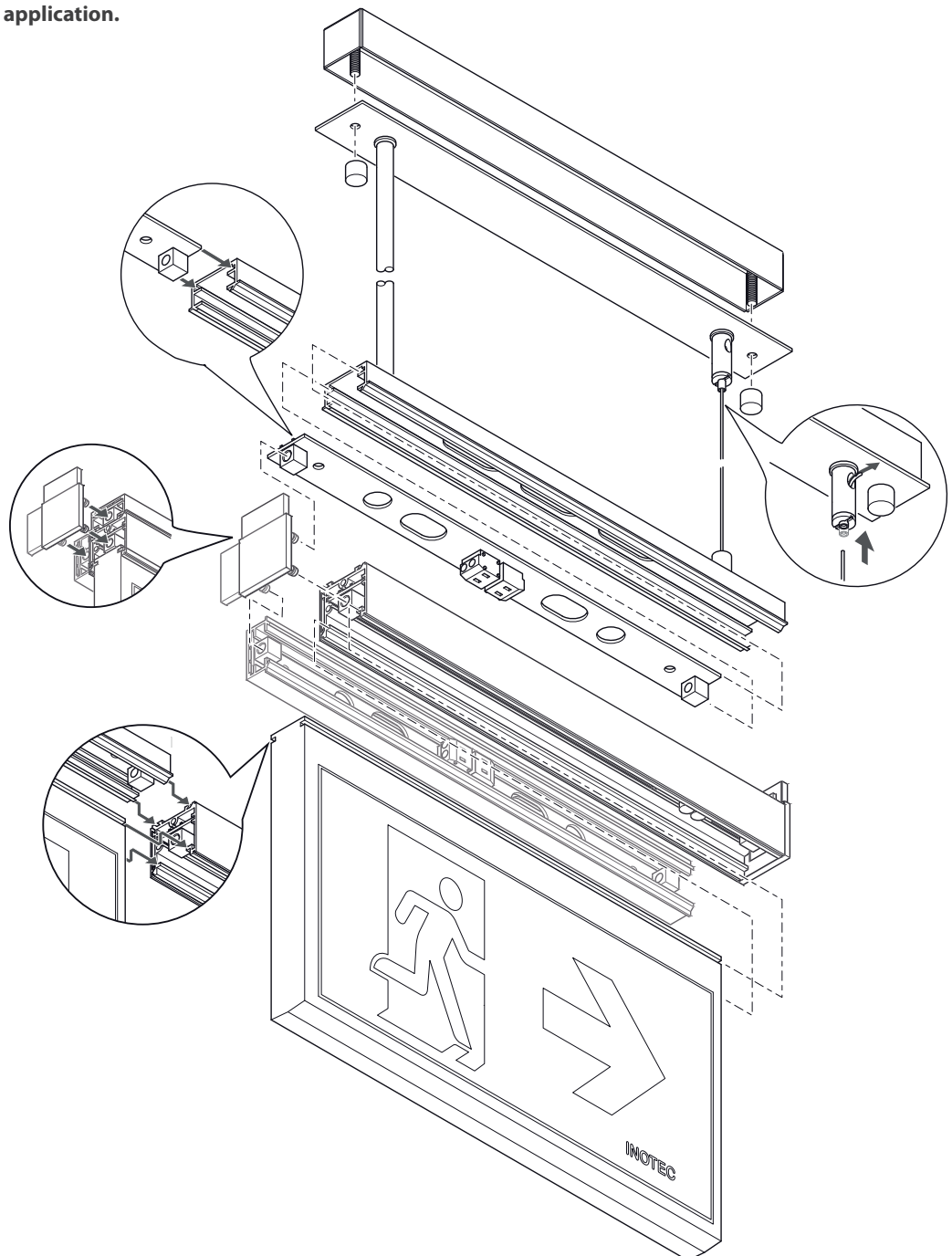



Discrete LED edge lights composed of high-quality anodised aluminium profile without any visible screws. Homogeneous illumination of the free hanging frameless 20 mm acrylic pictograph by state-of-the-art LED technology. Discreet housing thanks to latest 24V technology.

Technical data

Viewing distance:	16 m	Nominal current DC:	100 mA
Material:	Aluminium	Protection class:	III
Illuminant:	LEDs	Input terminals:	2.5mm ² feed through wiring
Nominal voltage DC:	24 V ±20 %	Temperature ta:	-15...+40 °C

Articles

SNP 1214 D LED 24V

Art. no. 810 000

Ceiling mounting

Protection category: IP40

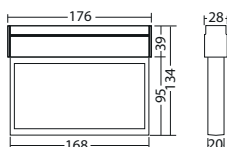

SNP 1214 P LED 24V

Art. no. 810 080

Pendulum mounting

Protection category: IP40

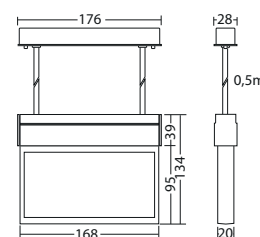

SNP 1214 PM LED 24V

Art. no. 810 001

Parallel wall mounting

Protection category: IP40

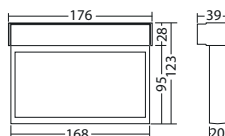

SNP 1214 S LED 24V

Art. no. 810 081

Cable suspension mounting

Protection category: IP40

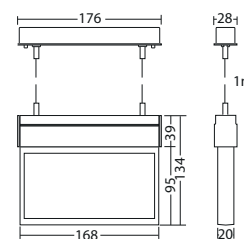

set for recessed ceiling mounting, white

Art. no. 890 404 L04

optional accessories

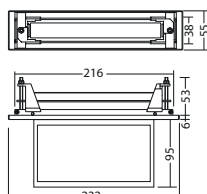

Name	Accessories	Art. no.



Discrete LED edge lights composed of high-quality anodised aluminium profile without any visible screws. Homogeneous illumination of the free hanging frameless 20 mm acrylic pictograph by state-of-the-art LED technology. Discreet housing thanks to latest 24V technology.

Technical data

Viewing distance:	22 m
Material:	Aluminium
Illuminant:	LEDs
Nominal voltage DC:	24 V ±20 %

Nominal current DC:	125 mA
Protection class:	III
Input terminals:	2.5mm ² feed through wiring
Temperature ta:	-15...+40 °C

Articles

SNP 1216 D LED 24V

Art. no. 810 002

Ceiling mounting

Protection category: IP40

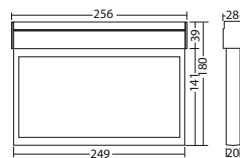

SNP 1216 P LED 24V

Art. no. 810 004

Pendulum mounting

Protection category: IP40

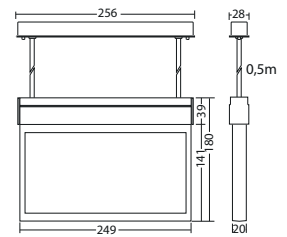

SNP 1216 PM LED 24V

Art. no. 810 003

Parallel wall mounting

Protection category: IP40

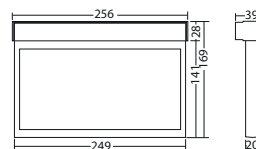

SNP 1216 S LED 24V

Art. no. 810 005

Cable suspension mounting

Protection category: IP40

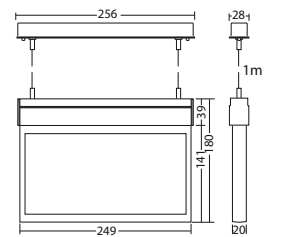

set for recessed ceiling mounting, white

Art. no. 890 405 L04

optional accessories

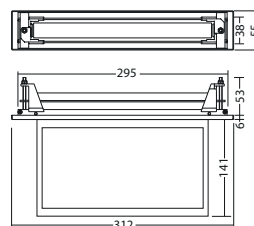

Name

Accessories

Art. no.







Aluminium luminaires

The all-rounders

The INOTEC aluminium profile luminaires are especially characterised by their versatile application possibilities. Due to the different housing sizes and the possibility of individual colour design, the aluminium profile luminaires can be well adapted to the interior architecture of the building.



Advantages

- Attractive design
- Easily exchangeable pictograms
- Tool-free opening

Applications

- Public buildings with elegant room architecture
- Offices
- Shop premises



SNP 7184/7284 98



SNP 7186/7286 102



SNP 7188/7288 104



SNP 7168.1 UP 107



Single sided aluminium profile emergency exit luminaires with additional light output at bottom side. Homogeneous illumination by state-of-the-art LED technology with a luminance of $> 500 \text{ cd/m}^2$.

Technical data

Viewing distance:	12 m	Nominal current DC:	80 mA
Material:	Aluminium	Protection class:	III
Illuminant:	LEDs	Input terminals:	2.5mm ² feed through wiring
Nominal voltage DC:	24 V \pm 20 %	Temperature ta:	-15...+40 °C

Available colours Add colour code to the article no. e.g. 800 014 LXX

Special colour: L99 

Articles

SNP 7184 LED 24V

Art. no. 810 058

Wall mounting

Protection category: IP40





Double-sided aluminium profile emergency exit luminaires with additional light output at bottom side. Homogeneous illumination by state-of-the-art LED technology with a luminance of $> 500 \text{ cd/m}^2$.

Technical data

Viewing distance:	12 m	Nominal current DC:	115 mA
Material:	Aluminium	Protection class:	III
Illuminant:	LEDs	Input terminals:	2.5mm ² feed through wiring
Nominal voltage DC:	24 V \pm 20 %	Temperature ta:	-15...+40 °C

Available colours Add colour code to the article no. e.g. 800 014 LXX

Special colour: L99 

Articles

SNP 7284 D LED 24V

Art. no. 810 042

Ceiling mounting

Protection category: IP40









Single sided aluminium profile emergency exit luminaires with additional light output at bottom side. Homogeneous illumination by state-of-the-art LED technology with a luminance of $> 500 \text{ cd/m}^2$.

Technical data

Viewing distance:	20 m	Nominal current DC:	80 mA
Material:	Aluminium	Protection class:	III
Illuminant:	LEDs	Input terminals:	2.5mm ² feed through wiring
Nominal voltage DC:	24 V \pm 20 %	Temperature ta:	-15...+40 °C

Available colours Add colour code to the article no. e.g. 800 014 LXX

Special colour: L99 

Articles

SNP 7186 LED 24V

Art. no. 810 021

Wall mounting

Protection category: IP40

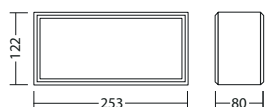



Double-sided aluminium profile emergency exit luminaires with additional light output at bottom side. Homogeneous illumination by state-of-the-art LED technology with a luminance of $> 500 \text{ cd/m}^2$.

Technical data

Viewing distance:	20 m	Nominal current DC:	115 mA
Material:	Aluminium	Protection class:	III
Illuminant:	LEDs	Input terminals:	2.5mm ² feed through wiring
Nominal voltage DC:	24 V \pm 20 %	Temperature ta:	-15...+40 °C

Available colours Add colour code to the article no. e.g. 800 014 LXX

Special colour: L99

Articles

SNP 7286 D LED 24V

Art. no. 810 022

Ceiling mounting

Protection category: IP40

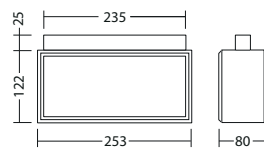

SNP 7286 K LED 24V

Art. no. 810 044

Chain mounting

Protection category: IP40

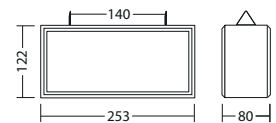

SNP 7286 P LED 24V

Art. no. 810 023

Pendulum mounting

Protection category: IP40

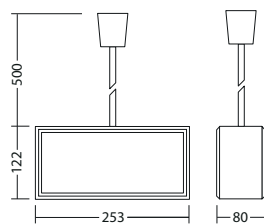

SNP 7286 WA LED 24V

Art. no. 810 045

Wall bracket mounting

Protection category: IP40

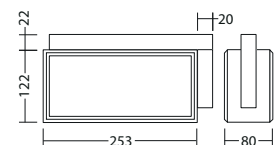



Single sided aluminium profile emergency exit luminaires with additional light output at bottom side. Homogeneous illumination by state-of-the-art LED technology with a luminance of $> 500 \text{ cd/m}^2$.

Technical data

Viewing distance:	35 m	Nominal current DC:	115 mA
Material:	Aluminium	Protection class:	III
Illuminant:	LEDs	Input terminals:	2.5mm ² feed through wiring
Nominal voltage DC:	24 V \pm 20 %	Temperature ta:	-15...+40 °C

Available colours Add colour code to the article no. e.g. 800 014 LXX

Special colour: L99 

Articles

SNP 7188 LED 24V

Art. no. 810 046

Wall mounting

Protection category: IP40

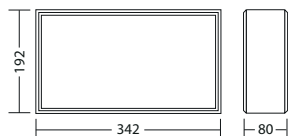



Double-sided aluminium profile emergency exit luminaires with additional light output at bottom side. Homogeneous illumination by state-of-the-art LED technology with a luminance of $> 500 \text{ cd/m}^2$.

Technical data

Viewing distance:	35 m	Nominal current DC:	200 mA
Material:	Aluminium	Protection class:	III
Illuminant:	LEDs	Input terminals:	2.5mm ² feed through wiring
Nominal voltage DC:	24 V $\pm 20 \%$	Temperature ta:	-15...+40 °C

Available colours Add colour code to the article no. e.g. 800 014 LXX

Special colour: L99 

Articles

SNP 7288 D LED 24V

Art. no. 810 047

Ceiling mounting

Protection category: IP40

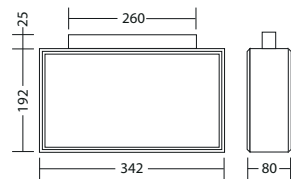

SNP 7288 K LED 24V

Art. no. 810 043

Chain mounting

Protection category: IP40

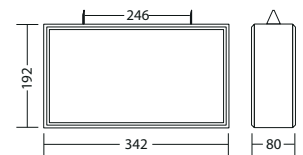

SNP 7288 P LED 24V

Art. no. 810 048

Pendulum mounting

Protection category: IP40

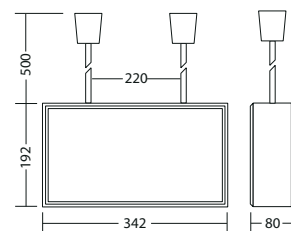

SNP 7288 S LED 24V

Art. no. 810 183

Cable suspension mounting

Protection category: IP40

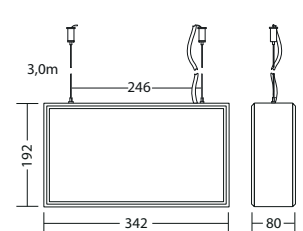

SNP 7288 WA LED 24V

Art. no. 810 049

Wall bracket mounting

Protection category: IP40

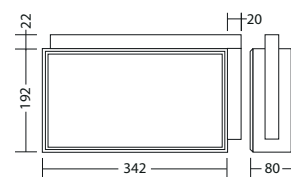





Single sided aluminium profile emergency exit luminaires for recessed wall mounting. Invisible frame with an installation depth of 60mm. Homogeneous illumination by state-of-the-art LED technology with a luminance of $> 500\text{cd/m}^2$.

Technical data

Viewing distance:	32 m	Nominal current DC:	115 mA
Material:	Aluminium	Protection class:	III
Illuminant:	LEDs	Input terminals:	2.5mm ² feed through wiring
Nominal voltage DC:	24 V \pm 20 %	Temperature ta:	-15...+40 °C

Available colours Add colour code to the article no. e.g. 800 014 **LXX**

Special colour: **L99**

Articles

SNP 7168.1 LED 24V

Art. no. 810 149

Recessed wall mounting

Protection category: IP40





Four-sided emergency exit sign luminaires

Thanks to their adaptable pictogram cover, the INOTEC emergency exit sign luminaires with four-sided light emission can be used for a wide range of applications and adapted to the escape route directions on site.

In addition to ceiling mounting with cable entry from the back, the installation box also offers the possibility of inserting cables from the side when routing cables on wall plaster or using wire or chain mounting.

The luminaires are available for two different viewing distances.



Advantages

- Reduced number of luminaires
- Easy assembly

Applications

- Storage areas
- Workplaces
- Shop premises



SNP 2420

111



SNP 2435

113





Four-sided emergency exit sign luminaire with anodized aluminium corner profile and multi-purpose installation box made of white UV- and filament resistant polycarbonate with optional side cable entry. Homogeneous pictogram illumination thanks to optimised LED technology with a luminance > 500 cd/m² and individually replaceable pictograms for each luminaire side.

Technical data

Viewing distance:	20 m	Nominal current DC:	110 mA
Material:	Polycarbonate	Protection class:	III
Illuminant:	LEDs	Input terminals:	2.5mm ² feed through wiring
Nominal voltage DC:	24 V ±20 %	Temperature ta:	-15...+40 °C

Articles

SNP 2420 LED 24V Art. no. 810 393

Ceiling mounting

Protection category: IP54

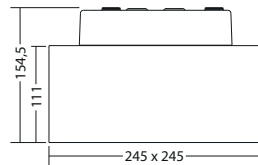

Ringbolts for SN 8500/24xx Art. no. 890 403

optional accessories

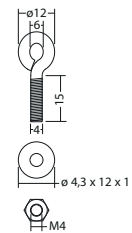

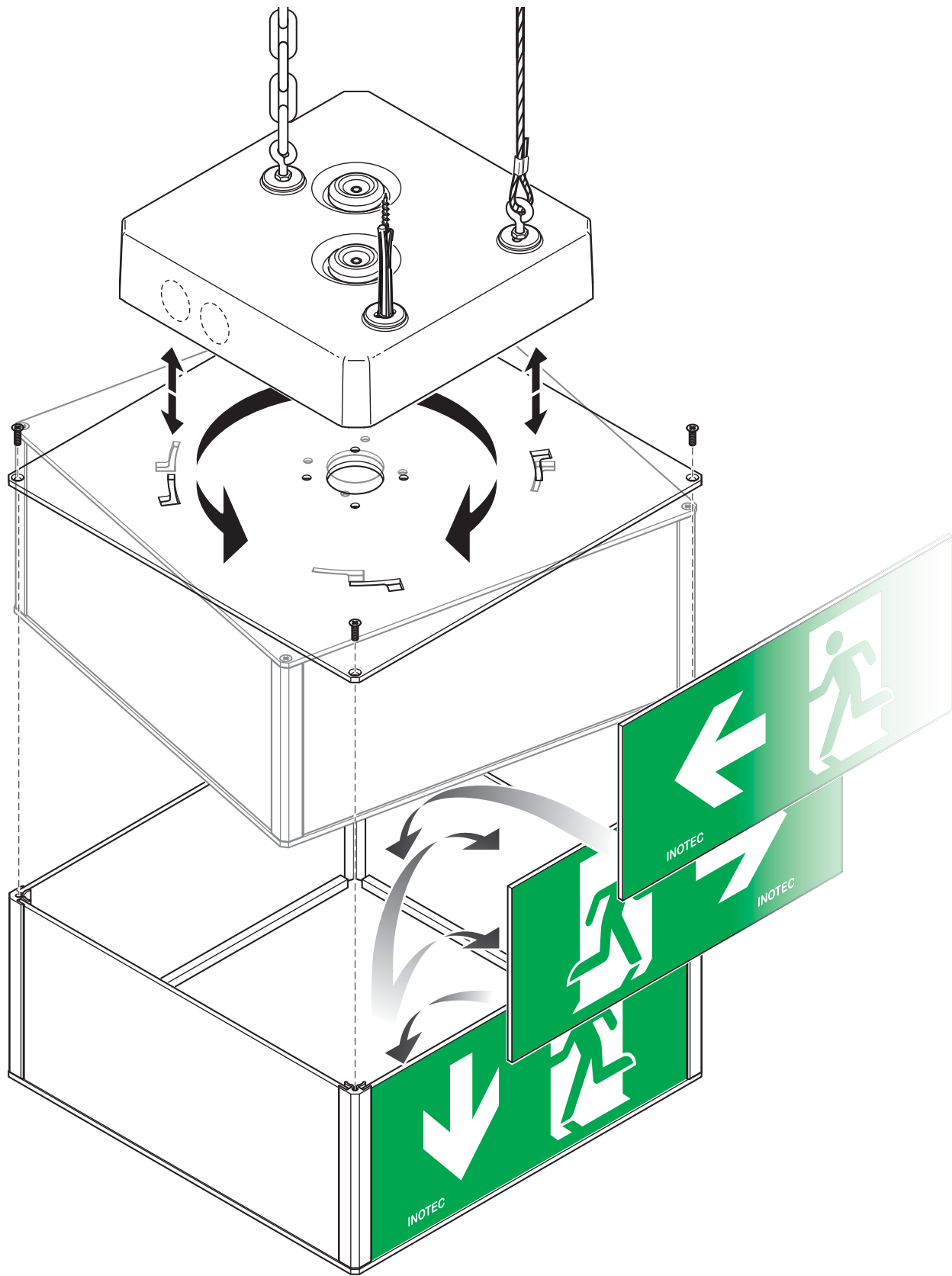



Four-sided emergency exit sign luminaire with anodized aluminium corner profile and multi-purpose installation box made of white UV- and filament resistant polycarbonate with optional side cable entry. Homogeneous pictogram illumination thanks to optimised LED technology with a luminance > 500 cd/m² and individually replaceable pictograms for each luminaire side.

Technical data

Viewing distance:	35 m	Nominal current DC:	185 mA
Material:	Polycarbonate	Protection class:	III
Illuminant:	LEDs	Input terminals:	2.5mm ² feed through wiring
Nominal voltage DC:	24 V ±20 %	Temperature ta:	-15...+40 °C

Articles

SNP 2435 LED 24V

Art. no. 810 394

Protection category: IP54

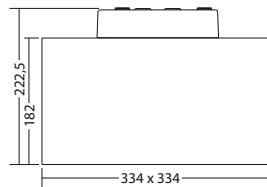

Ringbolts for SN 8500/24xx

Art. no. 890 403

optional accessories

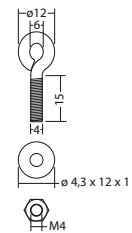



Wall and step luminaires

Safety and orientation luminaires









From top-quality LED step luminaires in stainless steel for the EN-compliant illumination of escape routes to luminaires with a high protection rating for emergency staircases (for instance): our range of wall and step luminaires contains something for every application.

Advantages

- Low power consumption
- Versatile mounting options
- Cutting-edge lighting technology

Areas of application

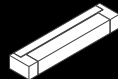
- Theatres
- Cinemas
- Staircases
- Lecture theatre
- etc.

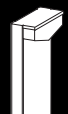
	SN 6109	117
	SN 6110	118
	SN 6114	120
	SN 6124	123
	SN 6203.1	125
	SN 6204.2	127
	SN(P) 2004.1	129
	SN 6205	131
	SN 6206-11	133
	SN 6307	135



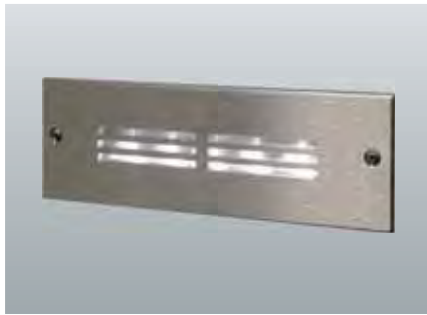

Rectangular LED safety luminaires to illuminate steps or escape routes. Recessed wall and stair mounting. Design with brushed stainless steel cover.

Technical data

Material:	Stainless steel	Nominal current DC:	115 mA
Illuminant:	LEDs	Protection class:	III
Luminous flux:	14 lm	Input terminals:	max. 1.5 mm ² single-core
Nominal voltage DC:	24 V ±20 %	Temperature ta:	-15...+40 °C

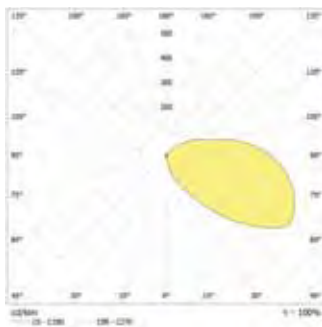

Articles

SN 6109 LED 24V rectangular, light output: grid

Art. no. 810 082

Recessed wall or stair mounting

Protection category: IP20

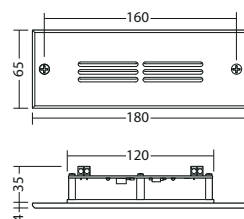



Rectangular LED safety luminaires to illuminate steps or escape routes. Recessed wall and stair mounting. Luminaire with powder-coated metal cover for installation in double wall box for concrete, cavity wall or in-wall.

Technical data

Material:	Sheet steel powder-coated	Nominal current DC:	115 mA
Illuminant:	LEDs	Protection class:	III
Luminous flux:	11 lm	Input terminals:	2.5mm ² feed through wiring
Nominal voltage DC:	24 V ±20 %	Temperature ta:	-15...+40 °C

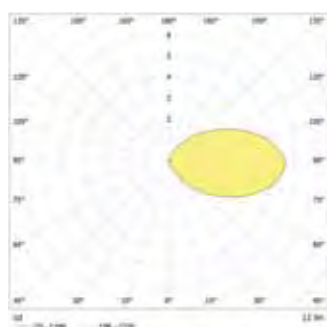

Articles

SN 6110 G LED 24V rectangular, light output: grid

Art. no. 810 165

Recessed wall or stair mounting

Protection category: IP20

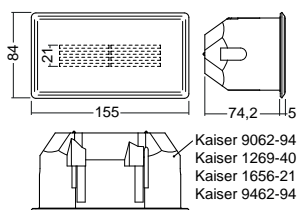



Rectangular LED safety luminaires to illuminate steps or escape routes. Recessed wall and stair mounting. Luminaire with powder-coated metal cover for installation in double wall box for concrete, cavity wall or in-wall.

Technical data

Material:	Sheet steel powder-coated	Nominal current DC:	115 mA
Illuminant:	LEDs	Protection class:	III
Luminous flux:	30 lm	Input terminals:	2.5mm ² feed through wiring
Nominal voltage DC:	24 V ±20 %	Temperature ta:	-15...+40 °C

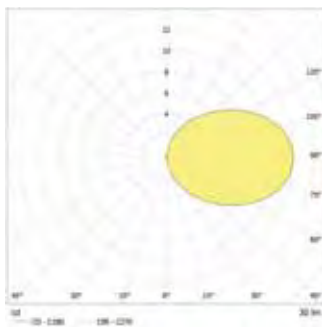

Articles

SN 6110 O LED 24V rectangular, light output: opal

Art. no. 810 164

Recessed wall or stair mounting

Protection category: IP20

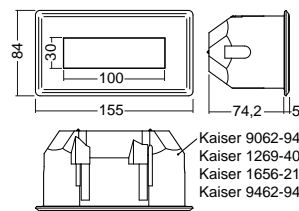



Robust LED safety luminaires to illuminate steps or escape routes. Recessed wall and stair mounting. Made of high-quality die-cast aluminium with high protection category.

Technical data

Material:	Die-cast aluminum	Nominal current DC:	150 mA
Illuminant:	LEDs	Protection class:	III
Luminous flux:	25 lm	Input terminals:	2.5mm ² feed through wiring
Nominal voltage DC:	24 V ±20 %	Temperature ta:	-15...+40 °C

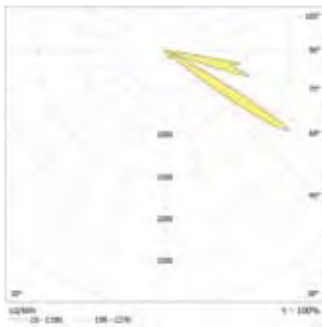

Articles

SN 6114 G LED 24V grids

Art. no. 810 070

Recessed wall or stair mounting

Protection category: IP54

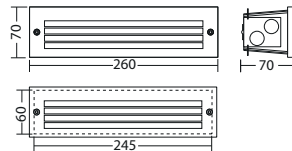



Robust LED safety luminaires to illuminate steps or escape routes. Recessed wall and stair mounting. Made of high-quality die-cast aluminium with high protection category.

Technical data

Material:	Die-cast aluminum	Nominal current DC:	150 mA
Illuminant:	LEDs	Protection class:	III
Luminous flux:	93 lm	Input terminals:	2.5mm ² feed through wiring
Nominal voltage DC:	24 V ±20 %	Temperature ta:	-15...+40 °C

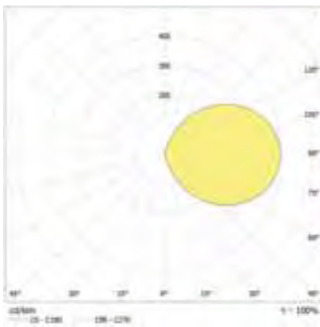

Articles

SN 6114 O LED 24V

Art. no. 810 072

Recessed wall or stair mounting

Protection category: IP54

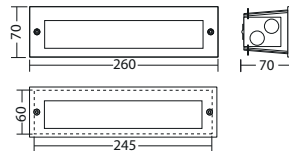





Round LED safety luminaires to illuminate steps or escape routes. Recessed wall and stair mounting in a 68mm switch-box. Design with brushed stainless steel cover.

Technical data

Material:	Stainless steel	Nominal current DC:	125 mA
Illuminant:	LEDs	Protection class:	III
Luminous flux:	40 lm	Input terminals:	2.5mm ² feed through wiring
Nominal voltage DC:	24 V ±20 %	Temperature ta:	-15...+40 °C

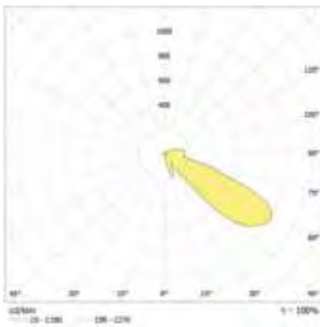

Articles

SN 6124 WE LED 24V round, light output: grid

Art. no. 806 300

Recessed wall or stair mounting

Protection category: IP20

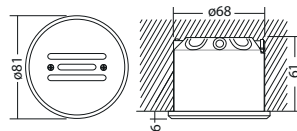



The SN 6203.1 emergency luminaire is made of high-quality aluminium and brushed stainless steel. The luminaire is suitable for mounting on stairs or walls. It is available with an opal lens or grid diffuser depending on the application. IP65 luminaire version incl. 1 x 10m connection cable H05RN-F 2 x 0.75 mm².

Technical data

Material:	Aluminium / Stainless steel brushed	Nominal current DC:	100 mA
Illuminant:	LEDs	Protection class:	III
Luminous flux:	53 lm	Input terminals:	max. 1.5 mm ² single-core
Nominal voltage DC:	24 V ±20 %	Temperature ta:	-15...+40 °C

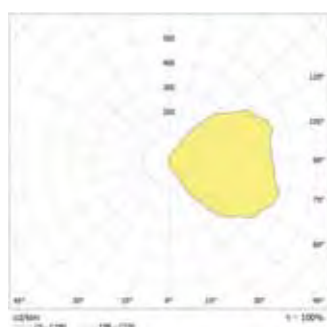

Articles

SN 6203.1 LED 24V

Art. no. 806 228

Wall or stair mounting

Protection category: IP40

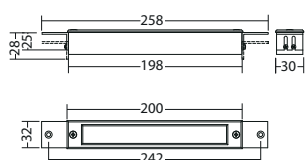

SN 6203.1 LED 24V

Art. no. 806 232

Wall or stair mounting

Protection category: IP65

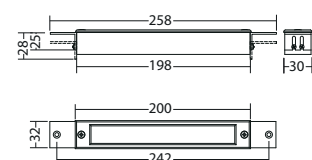

SN 6203.1 LED 24V

Art. no. 806 233

Recessed wall or stair mounting

Protection category: IP65

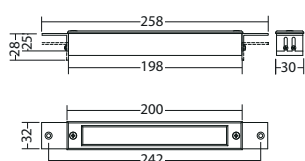



The SN 6203.1 emergency luminaire is made of high-quality aluminium and brushed stainless steel. The luminaire is suitable for mounting on stairs or walls. It is available with an opal lens or grid diffuser depending on the application.

IP65 luminaire version incl. 1 x 10m connection cable H05RN-F 2 x 0.75 mm².

Technical data

Material:	Aluminium / Stainless steel brushed	Nominal current DC:	100 mA
Illuminant:	LEDs	Protection class:	III
Luminous flux:	19 lm	Input terminals:	max. 1.5 mm ² single-core
Nominal voltage DC:	24 V ±20 %	Temperature ta:	-15...+40 °C

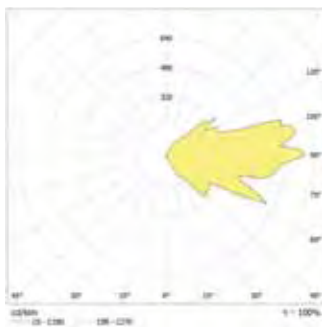

Articles

SN 6203.1 G LED 24V

Art. no. 806 230

Wall or stair mounting

Protection category: IP40

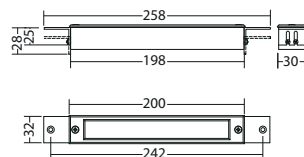

SN 6203.1 G LED 24V

Art. no. 806 234

Wall or stair mounting

Protection category: IP65

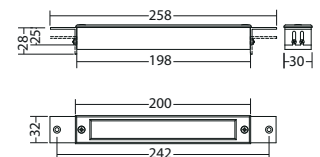

SN 6203.1 G LED 24V

Art. no. 806 235

Recessed wall or stair mounting

Protection category: IP65

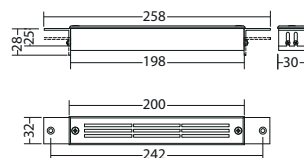



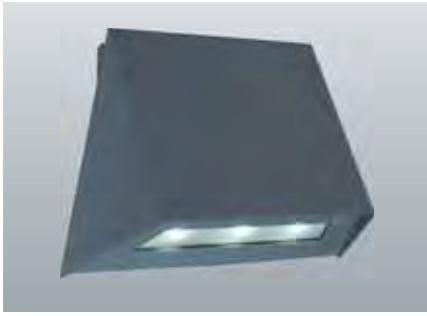

Trapezoidal LED safety luminaire for illumination of escape routes and exit doors. Luminaire for wall mounting with high protection category and elegant housing made of powder coated stainless steel without visible screws.

Technical data

Material:	Stainless steel powder-coated	Nominal current DC:	150 mA
Illuminant:	LEDs	Protection class:	III
Luminous flux:	210 lm	Input terminals:	2.5mm ² feed through wiring
Nominal voltage DC:	24 V ±20 %	Temperature ta:	-15...+40 °C

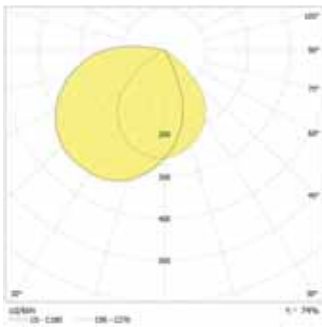

Minimum illumination 1.0 lx (middle of escape route), Maintenance factor 0.8

Distance to middle of escape route [m]	Distance to middle of escape route					
	1.0m		2.0m		3.0m	
1.0	2.2	5.4	2.3	5.7	1.8	5.2
2.0	2.8	7.0	2.8	7.2	2.3	6.8
2.5	3.0	7.4	3.0	7.8	2.6	7.4
3.0	3.1	8.0	3.1	8.4	2.7	8.1
3.5	3.2	8.5	3.2	8.7	2.8	8.5
4.0	3.1	8.7	3.1	9.1	2.8	8.8
4.5	3.0	9.0	3.0	9.3	2.7	9.0
5.0	2.8	9.0	2.8	9.3	2.5	9.1
5.5	2.6	9.0	2.6	9.3	2.0	9.1
6.0	2.2	8.8	2.1	9.2	1.5	8.9

Available colours Add colour code to the article no. e.g. 800 014 LXX

RAL 9016 (Traffic white): **L04** RAL 7015 (Slate grey): **L16** HWF 9016 (Traffic white): **HWF04** HWF 7015 (Slate grey): **HWF16** Special colour: **L99**

Articles

SN 6204.2 LED 24V

Art. no. 810 187

Wall mounting

Protection category: IP65

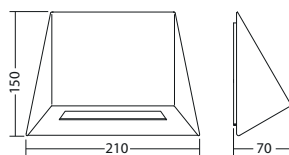
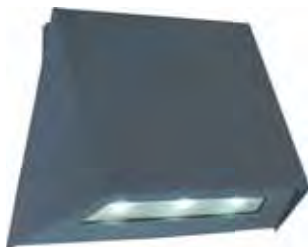

SN 6204.2 LED 24V

Art. no. 810 187

Wall mounting

Protection category: IP65

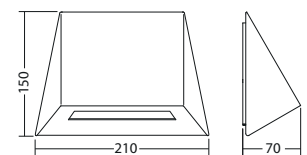

ground element bollard console

Art. no. 040 821

optional accessories

Protection category: IP54

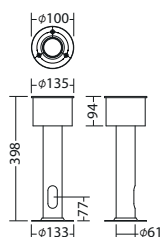

bollard console SN 6204 LED, RAL 7015

Art. no. 890 609 L16

optional accessories

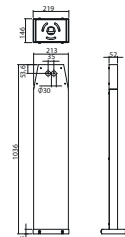

Combined safety and safety sign luminaire

Fire fighting and first aid facilities have to be specially marked and illuminated by 5lux according to EN 1838 of October 2013. The direct surrounding (distance of min. 2 meter) has to be illuminated as well.

The new combined safety and safety sign luminaire SNP 2004.1 is the ideale luminaire to indicate and illuminate areas with fire fighting equipment, first aid stations and other important areas.

Compared to an illuminated sign, back-lit emergency signs have the benefit of a very good visibility in bright surroundings due to their luminance of $> 500\text{cd/m}^2$. Fire fighting equipment and first aid facilities can be located very quickly in emergency situations. The integrated safety light will be switched on in case of a mains failure and illuminates the respective area according to the standards.

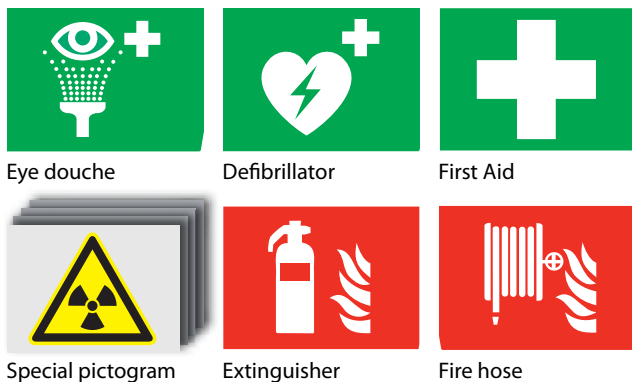



Versatile LED safety luminaire ideal for illumination of areas to be highlighted especially according to DIN EN 1838. Luminaire with separately switchable, backlit pictograph. UV resistant, heat filament tested polycarbonate housing for wall mounting with optional side cable entry.



Technical data

Viewing distance:	18 m	Nominal current DC:	265 mA
Material:	Polycarbonate	Protection class:	II
Illuminant:	LEDs	Input terminals:	2.5mm ² feed through wiring
Nominal voltage DC:	24 V ±20 %	Temperature ta:	-15...+40 °C

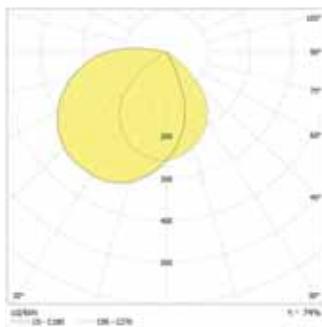

Minimum illumination 1.0 lx (middle of escape route), Maintenance factor 0.8

Distance to middle of escape route [m]	Distance to middle of escape route					
	1.0m		2.0m		3.0m	
1.0	2.2	5.4	2.3	5.7	1.8	5.2
2.0	2.8	7.0	2.8	7.2	2.3	6.8
2.5	3.0	7.4	3.0	7.8	2.6	7.4
3.0	3.1	8.0	3.1	8.4	2.7	8.1
3.5	3.2	8.5	3.2	8.7	2.8	8.5
4.0	3.1	8.7	3.1	9.1	2.8	8.8
4.5	3.0	9.0	3.0	9.3	2.7	9.0
5.0	2.8	9.0	2.8	9.3	2.5	9.1
5.5	2.6	9.0	2.6	9.3	2.0	9.1
6.0	2.2	8.8	2.1	9.2	1.5	8.9

Articles

SNP 2004.1 LED 24V

Art. no. 810 218 .1V

Wall mounting

Protection category: IP40

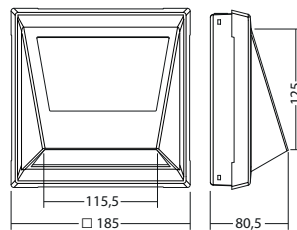



Versatile LED safety luminaire ideal for escape route or staircase illumination. UV resistant, heat filament tested polycarbonate housing for wall mounting with optional side cable entry.

Technical data

Material:	Polycarbonate	Nominal current DC:	150 mA
Illuminant:	LEDs	Protection class:	III
Luminous flux:	210 lm	Input terminals:	2.5mm ² feed through wiring
Nominal voltage DC:	24 V ±20 %	Temperature ta:	-15...+40 °C

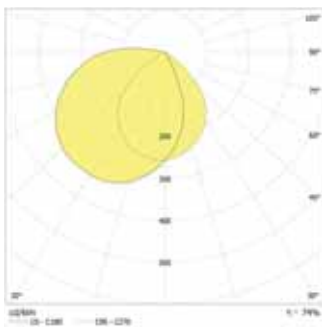

Minimum illumination 1.0 lx (middle of escape route), Maintenance factor 0.8

Distance (m)	Distance to middle of escape route					
	1.0m		2.0m		3.0m	
1.0	2.2	5.4	2.3	5.7	1.8	5.2
2.0	2.8	7.0	2.8	7.2	2.3	6.8
2.5	3.0	7.4	3.0	7.8	2.6	7.4
3.0	3.1	8.0	3.1	8.4	2.7	8.1
3.5	3.2	8.5	3.2	8.7	2.8	8.5
4.0	3.1	8.7	3.1	9.1	2.8	8.8
4.5	3.0	9.0	3.0	9.3	2.7	9.0
5.0	2.8	9.0	2.8	9.3	2.5	9.1
5.5	2.6	9.0	2.6	9.3	2.0	9.1
6.0	2.2	8.8	2.1	9.2	1.5	8.9

Articles

SN 2004.1 LED 24V

Art. no. 810 208 .1

Wall mounting

Protection category: IP40

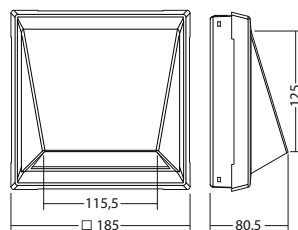

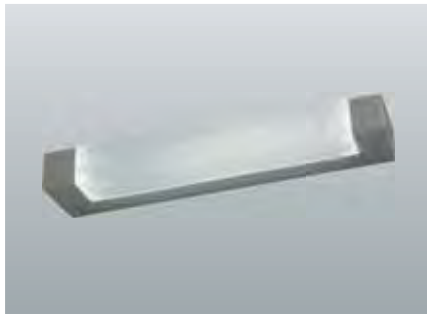

Elegant LED safety and orientation luminaire without any visible screws. Luminaire for wall mounting allowing individual, creative, project based safety- and signing concepts.

Technical data

Illuminant:	LEDs	Protection class:	III
Luminous flux:	97 lm	Input terminals:	2.5mm ² feed through wiring
Nominal voltage DC:	24 V ±20 %	Temperature ta:	-15...+40 °C
Nominal current DC:	115 mA		

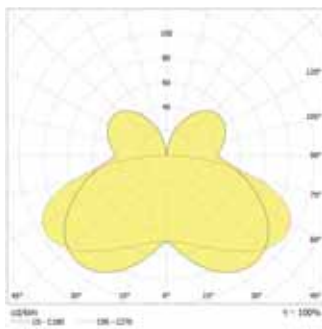

Articles

SN 6205 WS LED 24V

Art. no. 810 125

Wall mounting

Protection category: IP40

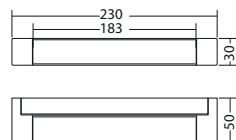



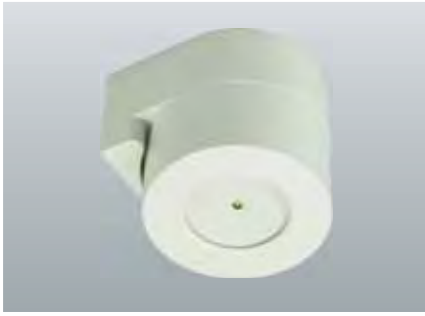

LED safety luminaire for illumination of escape routes and exit doors. Luminaire for wall mounting with high protection category and elegant housing made of powder coated aluminium without visible screws.

Technical data

Material:	Aluminium powder-coated	Nominal current DC:	80 mA
Illuminant:	LEDs	Protection class:	III
Luminous flux:	87 lm	Input terminals:	2.5mm ² feed through wiring
Nominal voltage DC:	24 V ±20 %	Temperature ta:	-15...+40 °C



Minimum illumination 1.0 lx (middle of escape route), Maintenance factor 0.8

Distance (m)	Beam diameter (mm)	Beam diameter (mm)
2.0	2.2	5.4
2.5	2.4	6.2
3.0	2.5	6.8
3.5	2.5	7.2
4.0	2.3	7.4
4.5	2.0	7.4
5.0	1.6	7.2
5.5	0.7	7.0

Articles

SN 6206-11 LED 24V

Art. no. 810 209

Wall mounting

Protection category: IP65

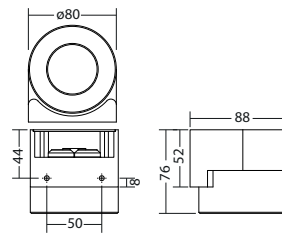





Elegant LED bollard luminaire ideal for outdoor escape route illumination made of powder-coated aluminium with high protection category.

Technical data

Material:	Aluminium powder-coated	Nominal current DC:	200 mA
Illuminant:	LEDs	Protection class:	III
Luminous flux:	178 lm	Input terminals:	2.5mm ² feed through wiring
Nominal voltage DC:	24 V ±20 %	Temperature ta:	-15...+40 °C

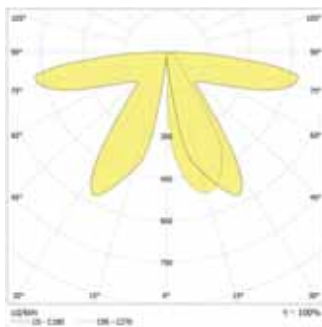

Minimum illumination 1.0 lx (middle of escape route), Maintenance factor 0.8

0.85	4.0	10.4

Articles

SN 6307 LED 24V

Art. no. 810 317

Floor installation



Protection category: IP54

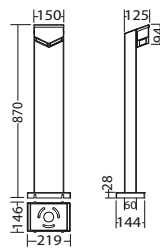

ground element bollard console

Art. no. 040 821

optional accessories



Protection category: IP54

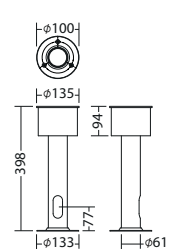



Stainless steel luminaires

Robust luminaire with high protection rating

INOTEC stainless steel luminaires are used wherever high degrees of protection and robust luminaire designs are required. The luminaires are available with fluorescent lamps or state-of-the-art LED technology.

Advantages

- Robust stainless steel housing A4 brushed
- Protection degree IP54 / IP65

Applications

- Food industry
- Work places with high demands
- Outdoor areas
- Carparks
- etc.



SNP 808 138



SNP 828 139



SN 804.1 WT 143



SN 804.1 145



Single sided emergency exit luminaires made of robust, brushed stainless steel with high protection category. Homogeneous illumination by state-of-the-art LED technology with a luminance of $>500\text{cd/m}^2$. Suitable for use in food industry or food processing plants with high demands on product hygiene.

Technical data

Viewing distance:	30 m	Nominal current DC:	115 mA
Material:	Stainless steel brushed	Protection class:	III
Illuminant:	LEDs	Input terminals:	2.5mm ² feed through wiring
Nominal voltage DC:	24 V \pm 20 %	Temperature ta:	-15...+40 °C

Available colours Add colour code to the article no. e.g. 800 014 **LXX**

stainless steel: **L30** ■ Special colour: **L99** ■

Articles

SNP 808 LED 24V

Art. no. 810 018

Wall mounting

Protection category: IP65

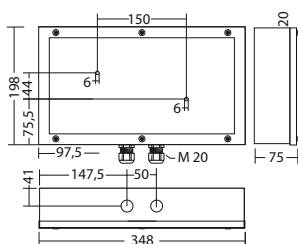



Double-sided emergency exit luminaires made of robust, brushed stainless steel with high protection category. Homogeneous illumination by state-of-the-art LED technology with a luminance of $>500\text{cd/m}^2$. Suitable for use in food industry or food processing plants with high demands on product hygiene.

Technical data

Viewing distance:	30 m	Nominal current DC:	200 mA
Material:	Stainless steel brushed	Protection class:	III
Illuminant:	LEDs	Input terminals:	2.5mm ² feed through wiring
Nominal voltage DC:	24 V \pm 20 %	Temperature ta:	-15...+40 °C

Available colours Add colour code to the article no. e.g. 800 014 **LXX**

stainless steel: **L30** ■ Special colour: **L99** ■

Articles

SNP 828 K LED 24V

Art. no. 810 011

Chain mounting

Protection category: IP65

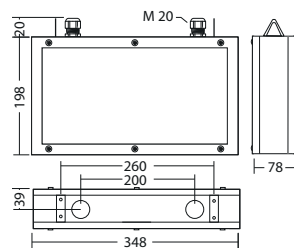

SNP 828 WA LED 24V

Art. no. 810 130

Wall bracket mounting

Protection category: IP65

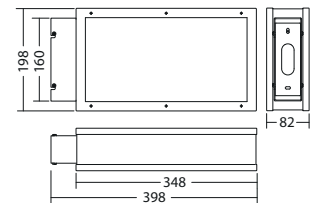

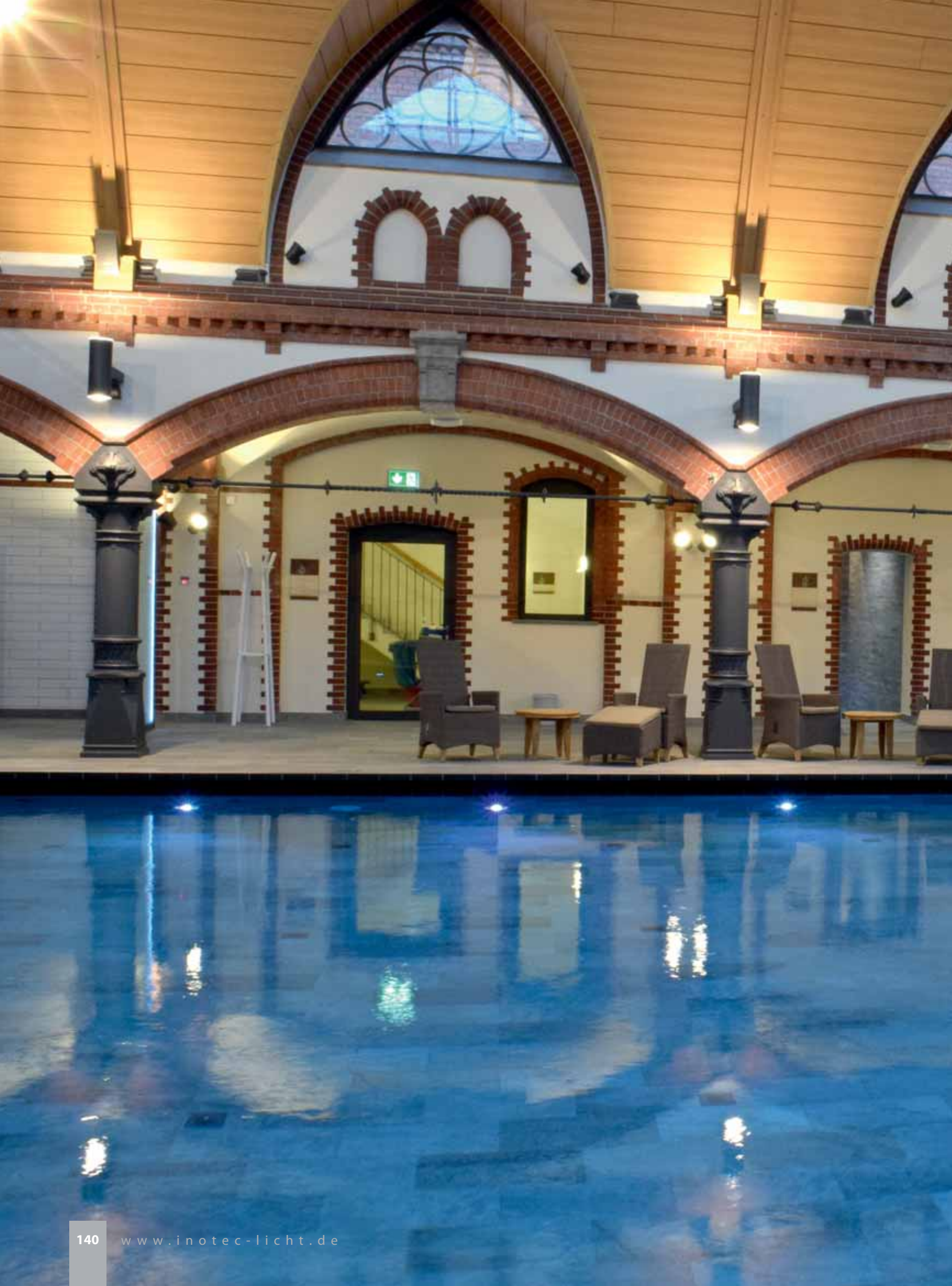



Standard-compliant safety lighting - up to the safe area



Safety lighting outside buildings up to a safe area, as required by EN 1838, is often difficult to provide. The supply of general lighting in outdoor areas or mast luminaires with high output is related to a bigger system as well as a higher battery capacity and therefore is very costly.

The new bollard luminaire SN 6307 is the ideal luminaire to illuminate outdoor areas due to its low power consumption and the high degree of protection IP54. The optimised light technology allows distances between two luminaires of more than 10m.

The new safety luminaire SN 804.1 WT is an alternative if it's not possible to use a bollard luminaire due to the structural design of a building. This luminaire illuminates the escape route with 1 lux at mounting heights of up to 32m. This means that the luminaire can be mounted unobtrusively at high altitudes. The practical, lockable mounting bracket can be used for adjusting the luminaire to the corresponding escape area.





Robust stainless steel luminaires for illuminating surfaces and escape routes. Luminaire made of brushed stainless steel with high protection class and special low beam optics for suspension heights up to 32m.

Technical data

Material:	Stainless steel brushed	Nominal current DC:	200 mA
Illuminant:	LEDs	Protection class:	III
Luminous flux:	339 lm	Input terminals:	2.5mm ² feed through wiring
Nominal voltage DC:	24 V ±20 %	Temperature ta:	-15...+40 °C

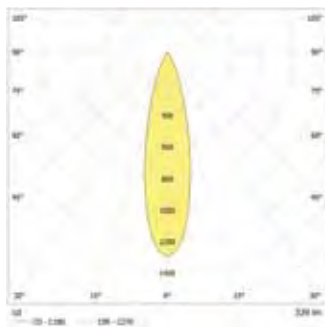

Minimum illumination 1.0 lx (middle of escape route), Maintenance factor 0.8

Height [m]	Beam width [m]	Beam width [m]
11.0	4.6	11.1
12.0	4.7	11.5
14.0	4.9	12.5
16.0	5.0	13.2
18.0	5.0	13.7
20.0	5.0	14.0
22.0	4.9	14.2
24.0	4.6	14.3
26.0	4.2	14.3
28.0	3.7	14.1
30.0	2.9	14.1
32.0	0.9	13.6

Minimum illumination 1.0 Lux (area illumination), Maintenance factor 0.8

Height [m]	Beam width [m]	Beam width [m]
11.0	3.3	9.0
12.0	3.6	9.5
14.0	3.7	10.3
16.0	3.7	11.1
18.0	3.7	11.8
20.0	3.7	12.2
22.0	3.6	12.7
24.0	3.6	12.8
26.0	3.5	12.8
28.0	3.2	12.4
30.0	3.0	12.2
32.0	2.8	12.1

Available colours Add colour code to the article no. e.g. 800 014 **LXX**

stainless steel: **L30** ■ Special colour: **L99** ■

Articles

SN 804.1 W T LED 24V

Art. no. 810 215

Wall bracket mounting

Protection category: IP65

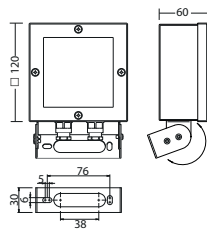





Robust brushed stainless steel luminaires with high protection category and latest LED-technology for area or escape route illumination. Suitable for use in food industry or food processing plants with high demands on product hygiene.

Technical data

Material:	Stainless steel brushed
Illuminant:	LEDs
Luminous flux:	310 lm
Nominal voltage DC:	24 V ±20 %

Nominal current DC:	200 mA
Protection class:	III
Input terminals:	2.5mm ² feed through wiring
Temperature ta:	-15...+40 °C

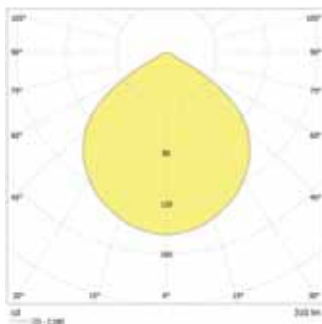

Minimum illumination 1.0 lx (middle of escape route), Maintenance factor 0.8

(m)	3.7	8.5
2.5	3.7	8.5
3.0	4.1	9.7
4.0	4.7	11.5
5.0	5.0	12.9
6.0	5.1	13.9
7.0	4.9	14.3
8.0	4.5	14.4
9.0	3.7	14.3
10.0	2.5	13.8

Minimum illumination 1.0 Lux (area illumination), Maintenance factor 0.8

(m)	2.7	6.4
2.5	2.7	6.4
3.0	3.1	7.3
4.0	3.6	9.0
5.0	3.7	10.6
6.0	3.7	11.8
7.0	3.6	12.4
8.0	3.4	12.8
9.0	3.1	12.6
10.0	2.6	12.4

Available colours Add colour code to the article no. e.g. 800 014 **LXX**

stainless steel: **L30** ■ Special colour: **L99** ■

Articles**SN 804.1 AP LED 24V**

Art. no. 810 213

ceiling mounting for exposed wiring

Protection category: IP65

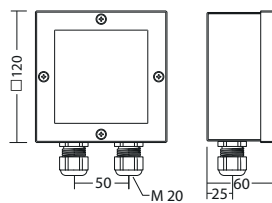
**SN 804.1 D LED 24V**

Art. no. 810 211

Ceiling mounting

Protection category: IP65

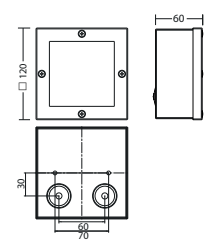
**SN 804.1 E LED 24V**

Art. no. 810 212

Recessed ceiling mounting

Protection category: IP65

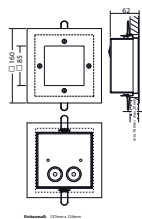
**SN 804.1 W LED 24V**

Art. no. 810 210

Wall bracket mounting

Protection category: IP65

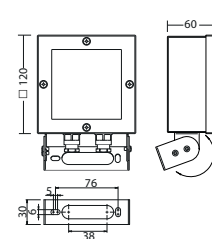



Downlights

Powerful and variable







INOTEC offers a wide range of downlights, both with classic fluorescent lamps and with cutting-edge LED technology. Variable mounting and fixing options ensure the right solution for every application.

Advantages

- Low power consumption
- Easy to install
- Cutting-edge lighting technology

Areas of application

- Public buildings
- Workplaces
- High-bay warehouses
- Congress centres
- Hotels
- Office buildings
- Sales outlets
- etc.

	SN 9024	149
	SN 9100 TES	151
	SN 9424	157
	SN 8424	163
	SN 8500	171
	SN 8040	173
	SN 8106-11	175







Elegant LED downlight for recessed ceiling mounting or luminaire integration with anodised aluminium cover without any visible screws. Ideal for area or escape route illumination.

Technical data

Material:	Aluminium powder-coated	Nominal current DC:	80 mA
Illuminant:	LEDs	Protection class:	III
Luminous flux:	70 lm	Input terminals:	2.5mm ² feed through wiring
Nominal voltage DC:	24 V ±20 %	Temperature ta:	-15...+40 °C

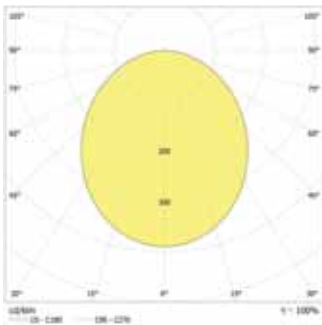

Minimum illumination 1.0 lx (middle of escape route), Maintenance factor 0.8

2.5	2.1	5.9
3.0	2.0	6.0
3.5	1.8	6.1
4.0	1.5	5.9

Minimum illumination 1.0 Lux (area illumination), Maintenance factor 0.8

2.5	1.5	5.2
3.0	1.5	5.5
3.5	1.5	5.5
4.0	1.5	5.5

Available colours Add colour code to the article no. e.g. 800 014 LXX

RAL 9016 (Traffic white): **L04** Special colour: **L99**

Articles

SN 9024 E LED 24V round

Art. no. 890 546

Recessed ceiling mounting

Protection category: IP20

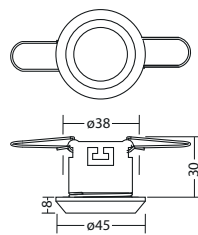

SN 9024 E LED 24V square

Art. no. 890 548

Recessed ceiling mounting

Protection category: IP20

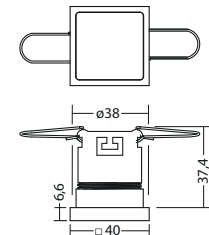

LED-Supply 24-3 SK III ext.

Art. no. 890 453

required

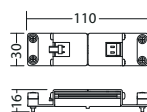

High-quality aluminium recessed downlight with INOTEC TES technology

The elegant and compact recessed downlight SN 9100, made from high-quality aluminium, can be discreetly and unobtrusively integrated into practically any ceiling design.

The new INOTEC TES (Translucent Emitting Surface) technology ensures, for the same power consumption, a 20%-higher luminous efficiency compared to conventional warm-white power LEDs. A back-lit, light-emitting disc creates a rotationally symmetrical and uniform emission pattern.

The SN 9100 is available in a choice of three different light colours (2700K, 3500K and 4300K) and, therefore, is not only ideal as a safety luminaire but also meets all the requirements for pleasant corridor lighting.

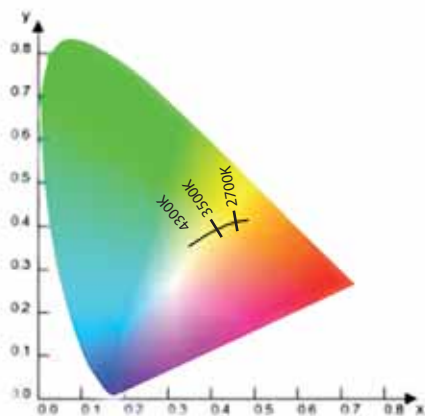
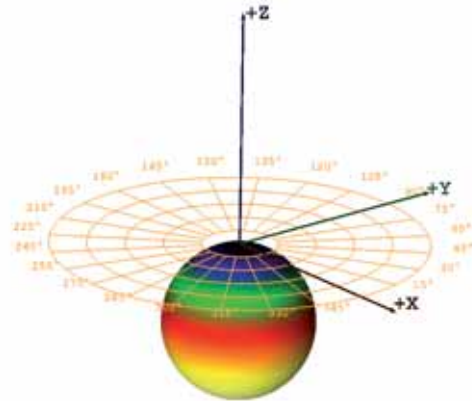



High-quality LED downlight, ideal for area or escape route illumination. Perfect for combined usage of safety and general lighting. Possible adaption to the light colour of the general lighting by Translucent-Emitting-Surface (TES) technology. Powder-coated aluminium housing without any visible screws designed for tool-less recessed ceiling installation in a ceiling cut-out Ø 72mm.

Technical data

Material:	Aluminium powder-coated
Illuminant:	LEDs
Luminous flux:	261 lm
Nominal voltage DC:	24 V ±20 %

Nominal current DC:	200 mA
Protection class:	III
Input terminals:	2.5mm ² feed through wiring
Temperature ta:	-15...+40 °C



Minimum illumination 1.0 lx (middle of escape route), Maintenance factor 0.8

Beam diameter (mm)	Beam diameter (mm)	Beam diameter (mm)
2.5	3.7	9.4
3.0	3.8	10.1
4.0	4.1	11.0
5.0	4.1	11.6
6.0	3.8	11.7

Minimum illumination 1.0 Lux (area illumination), Maintenance factor 0.8

Beam diameter (mm)	Beam diameter (mm)	Beam diameter (mm)
2.5	2.5	8.0
3.0	2.7	8.6
4.0	2.7	9.8
5.0	2.7	10.6
6.0	2.7	10.6

Available colours Add colour code to the article no. e.g. 800 014 **LXX**

RAL 9016 (Traffic white): **L04** Special colour: **L99**

Articles

SN 9100 LED 24V round Art. no. 809 001

Recessed ceiling mounting Light colour: 2700 K Protection category: IP20

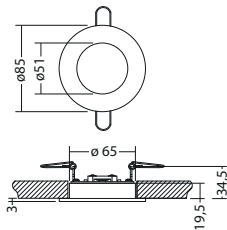

SN 9100 LED 24V round Art. no. 809 002

Recessed ceiling mounting Light colour: 3500 K Protection category: IP20

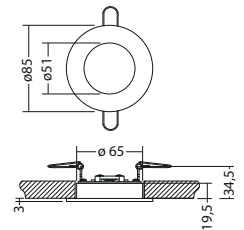

SN 9100 LED 24V round Art. no. 809 003

Recessed ceiling mounting Light colour: 4300 K Protection category: IP20

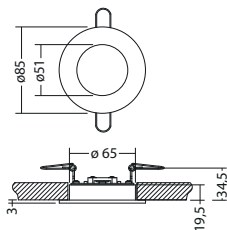

LED-supply 24-3 SK III ext. Art. no. 890 613

required

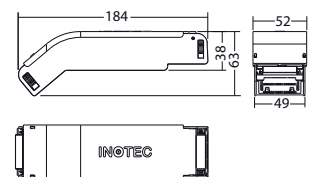



New range of downlights for more safety and efficiency

The new downlights are housed in top quality, power coated die cast aluminium.

The discreet and unobtrusive design blends inconspicuously into existing architectures.

A highly efficient power LED of the latest generation combined with excellent thermal management ensures a luminous flux of more than 160 lm/W.

In addition, the multi-chip LED used offers a higher level of safety. With INOTEC FUSION CPS and CLS emergency lighting systems, even the failure of a single chip can be detected.

Secondary optics are used to take the best possible advantage of the LED luminous flux.

They ensure the efficient illumination of escape routes or areas with different mounting heights.

Practical luminaire spacing with the lowest possible current consumption was a key area of focus.

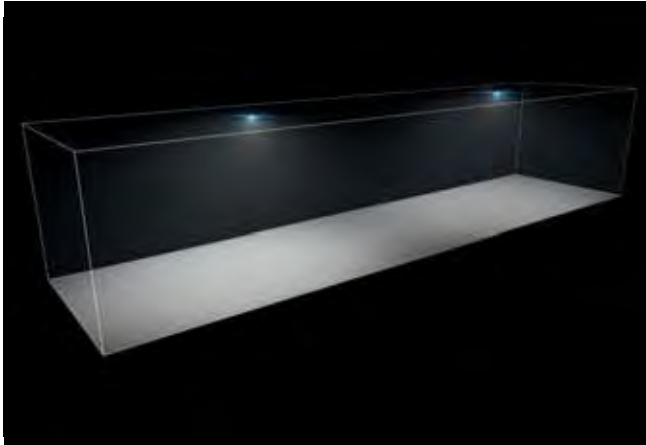

ALB - Asymmetric Low Bay

Luminaires with asymmetrical light distribution ALB are especially suitable for escape routes with low mounting heights.

The light distribution curve is designed to illuminate escape routes efficiently and in compliance with regulations.

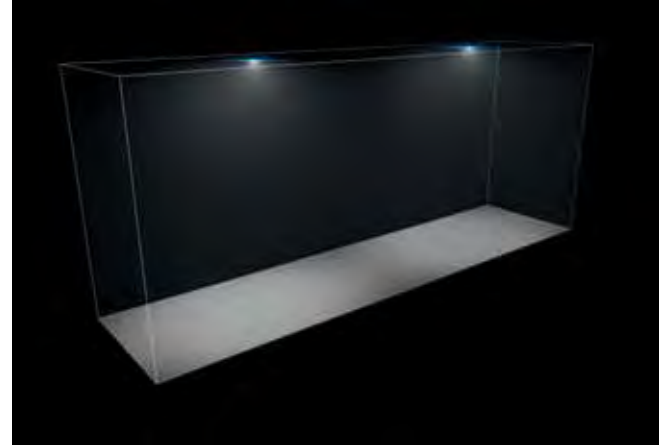

AHB - Asymmetric High Bay

Luminaires with asymmetrical light distribution AHB are especially suitable for escape routes with large mounting heights.

The light distribution curve is designed to illuminate escape routes efficiently and in compliance with regulations.

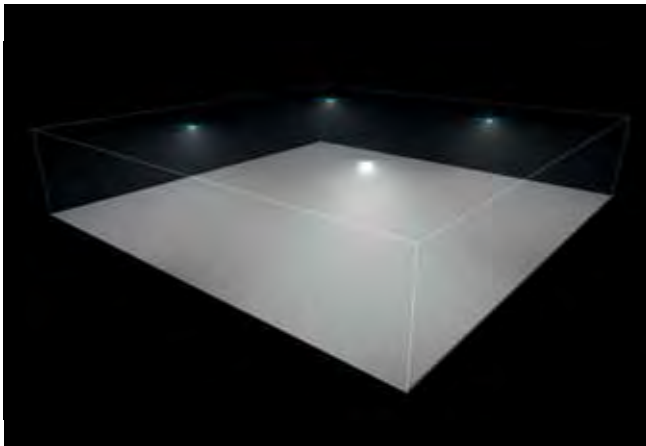

SLB - Symmetric Low Bay

Luminaires with symmetrical light distribution SLB are especially suitable for escape routes with low mounting heights.

The light distribution curve is designed to illuminate escape routes efficiently and in compliance with regulations.

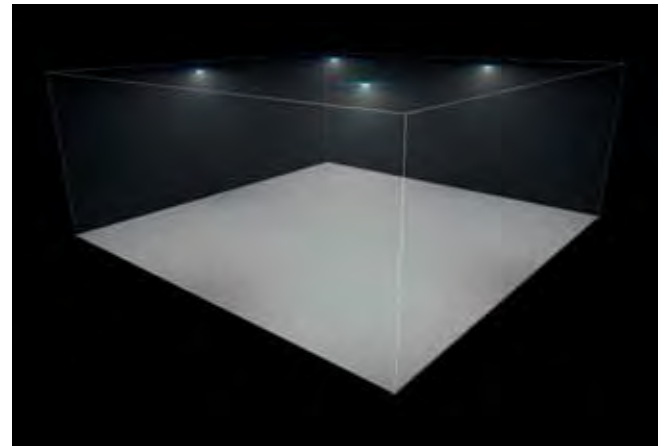

SHB - Symmetric High Bay

Luminaires with symmetrical light distribution SHB are especially suitable for escape routes with large mounting heights.

The light distribution curve is designed to illuminate escape routes efficiently and in compliance with regulations.



Illuminate highlighted areas in accordance with standards

EN 1838 requires safety lighting for highlighted areas. A higher lighting level is specified for first-aid stations, fire-fighting and alarm equipment.

In order to provide adequate visual conditions in the event of a power failure, the vertical illuminance at these installations shall be 5lx.

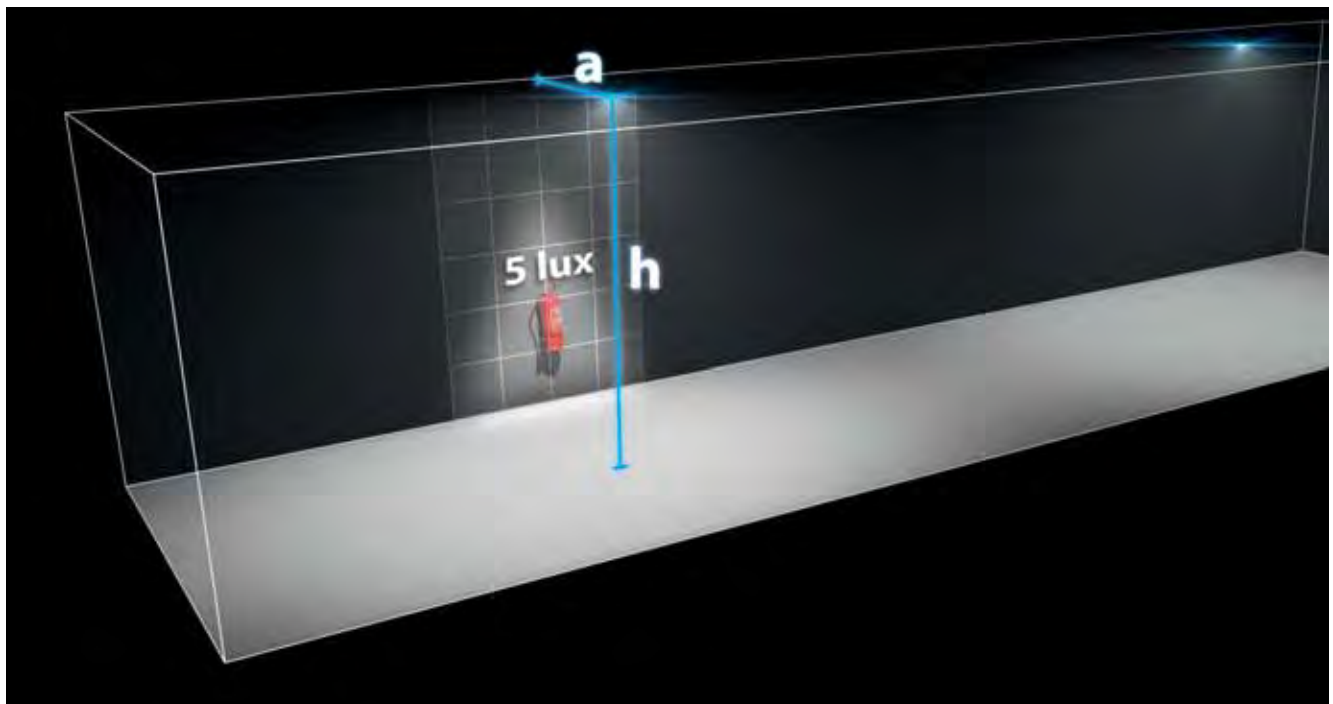

AHB –for 5lx at highlighted places

The luminaires with asymmetrical light distribution for high mounting heights (AHB) can be mounted crosswise to the escape route and used as emergency luminaires for highlighted areas with an illuminance of 5lx.

Distance Wall – Luminaire (a)

0,75 m = —

1,00 m = —

1,50 m = —

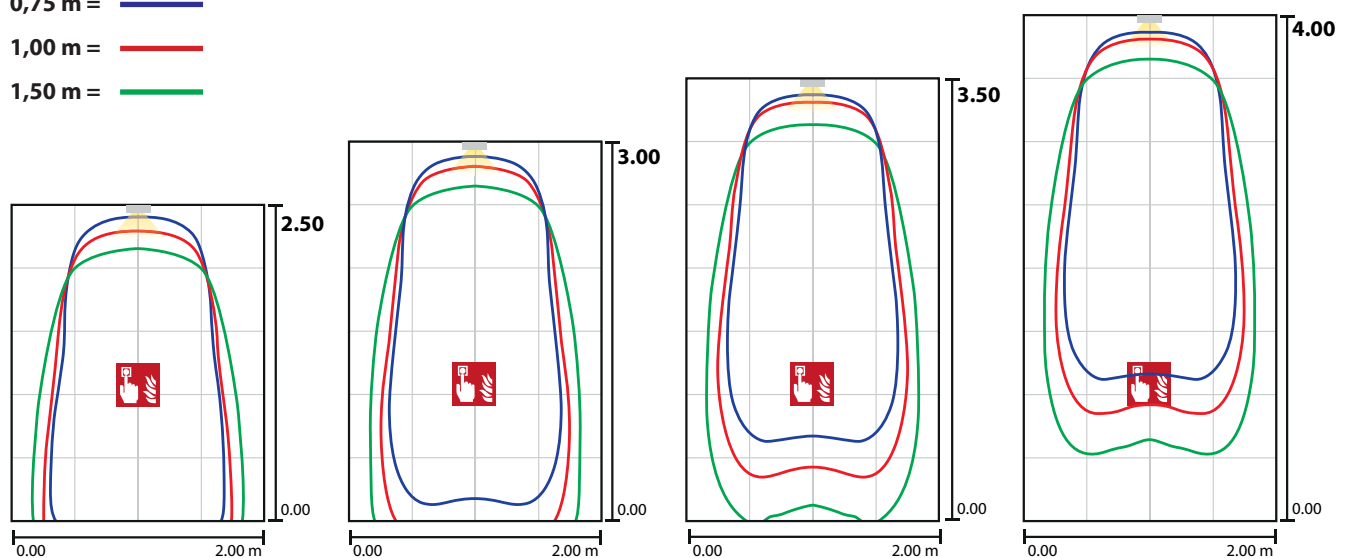

Flexible mounting

Due to the small 24V modules, it is possible to install the SN 9424 luminaire series including LED driver in various junction boxes.

This makes it easy to install the luminaires in suspended ceilings or concrete ceilings. With the Kaiser ceiling box HWD 30, it is also possible to integrate the luminaires into F30 to F90 fire protection ceilings without endangering the fire resistance class.

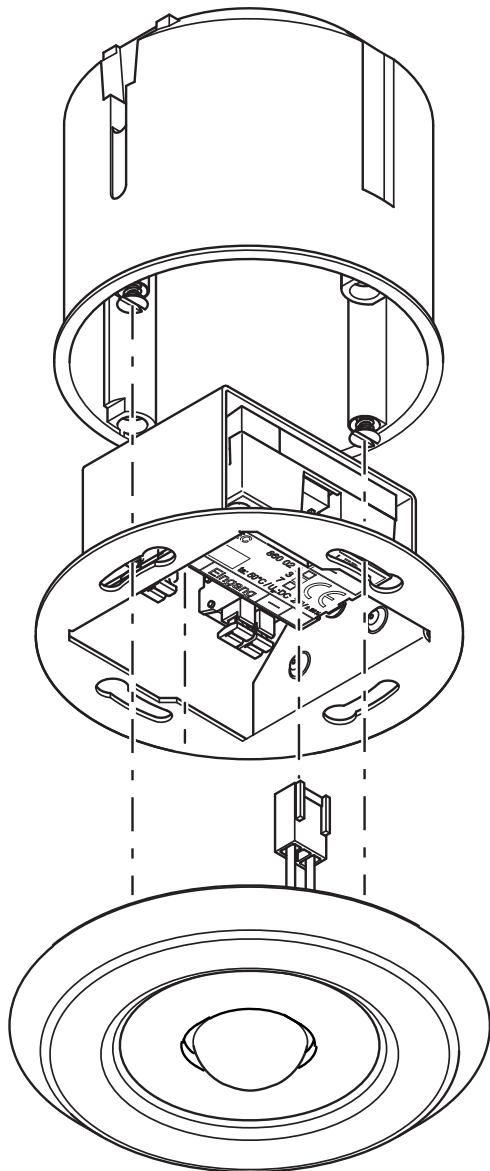

Kaiser junction box for concrete (Art.-No. 1265-40)



Kaiser ceiling box HWD 30 for fire protection ceilings F30 - F90 (Art.-No. 9464-50)



Kaiser junction box for recessed ceilings (Art.-No. 9064-01)



LED safety luminaire with optimised light distribution for the illumination of spaces. Recessed ceiling luminaires with powder-coated aluminium trim without visible screws. For installation in Ø 68mm socket. Incl. 4-chip LED illuminant for maximum safety.

Technical data

Material:	Die-cast aluminum powder-coated	Nominal current DC:	120 mA
Illuminant:	LEDs	Protection class:	III
Luminous flux:	322 lm	Input terminals:	2.5mm ² feed through wiring
Nominal voltage DC:	24 V ±20 %	Temperature ta:	-15...+40 °C

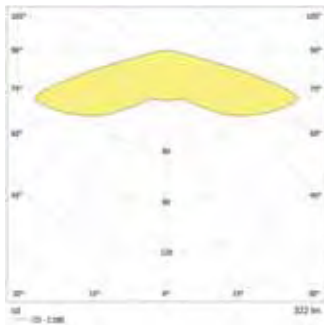

Minimum illumination 1.0 lx (middle of escape route), Maintenance factor 0.8

(m)	lx	lx
2.5	4.7	12.9
3.0	4.6	13.2
3.5	4.4	13.3
4.0	3.8	13.2
4.5	2.4	12.8

Minimum illumination 1.0 Lux (area illumination), Maintenance factor 0.8

(m)	lx	lx
2.5	3.7	11.7
3.0	3.7	12.3
3.5	3.2	12.8
4.0	2.9	12.3
4.5	2.6	12.3
5.0	2.4	12.3
5.5	2.2	10.8
6.0	2.0	9.9

Available colours Add colour code to the article no. e.g. 800 014 LXX

RAL 9016 (Traffic white): **L04** Special colour: **L99**

Articles

SN 9424-12 SLB LED 24V round

Art. no. 810 400

Switch box installation Light colour: 4000 K Protection category: IP20

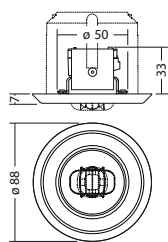

SN 9424-12 SLB LED 24V square

Art. no. 810 404

Switch box installation Light colour: 4000 K Protection category: IP20

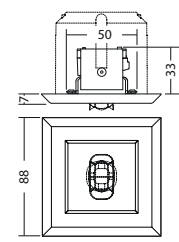



LED safety luminaire with optimised light distribution for the illumination of spaces with high mounting heights. Recessed ceiling luminaires with powder-coated aluminium trim without visible screws. Tool-less installation in Ø 68mm ceiling cutout. Incl. 4-chip LED illuminant for maximum safety.

Technical data

Material:	Die-cast aluminum powder-coated	Nominal current DC:	185 mA
Illuminant:	LEDs	Protection class:	III
Luminous flux:	545 lm	Input terminals:	2.5mm ² feed through wiring
Nominal voltage DC:	24 V ±20 %	Temperature ta:	-15...+40 °C

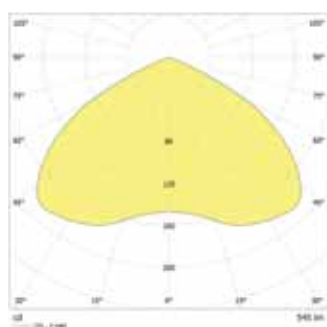

Minimum illumination 1.0 lx (middle of escape route), Maintenance factor 0.8

(m)	⊙	⊙
6.0	6.9	17.5
6.5	7.0	18.1
7.0	7.1	18.6
7.5	7.1	19.0
8.0	6.9	19.3
8.5	6.7	19.6
9.0	6.3	19.8
9.5	5.8	20.0
10.0	5.2	20.1

Minimum illumination 1.0 Lux (area illumination), Maintenance factor 0.8

(m)	⊙	⊙
6.0	4.9	14.2
6.5	5.1	14.7
7.0	5.0	14.9
7.5	4.9	16.2
8.0	4.7	16.3
8.5	4.7	16.8
9.0	4.6	17.5
9.5	4.5	17.7
10.0	4.3	16.6

Available colours Add colour code to the article no. e.g. 800 014 **LXX**

RAL 9016 (Traffic white): **L04** Special colour: **L99**

Articles

SN 9424-12 SHB LED 24V round

Art. no. 810 401

Switch box installation Light colour: 4000 K Protection category: IP20

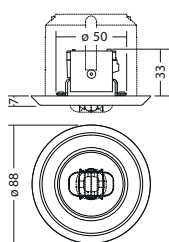

SN 9424-12 SHB LED 24V square

Art. no. 810 405

Switch box installation Light colour: 4000 K Protection category: IP20

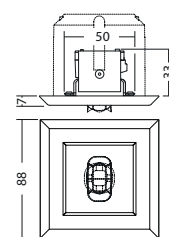



LED safety luminaire with optimised light distribution for the illumination of escape routes. Recessed ceiling luminaires with powder-coated aluminium trim without visible screws. For installation in Ø 68mm socket. Incl. 4-chip LED illuminant for maximum safety.

Technical data

Material:	Die-cast aluminum powder-coated	Nominal current DC:	65 mA
Illuminant:	LEDs	Protection class:	III
Luminous flux:	139 lm	Input terminals:	2.5mm ² feed through wiring
Nominal voltage DC:	24 V ±20 %	Temperature ta:	-15...+40 °C

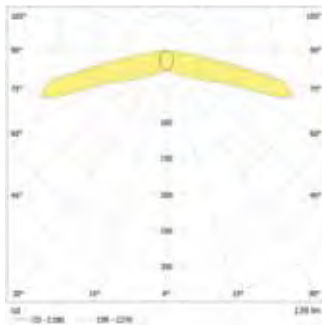

Minimum illumination 1.0 lx (middle of escape route), Maintenance factor 0.8

Distance (m)	Beam diameter (mm)	Illuminance (lx)	Beam diameter (mm)	Illuminance (lx)
2.5	6.8	17.0	5.3	1.9
3.0	5.3	18.1	5.4	1.8
3.5	4.8	17.9	5.4	1.6
4.0	3.8	17.3	5.3	1.3
4.5	3.0	14.3	5.0	0.9

Available colours Add colour code to the article no. e.g. 800 014 LXX

RAL 9016 (Traffic white): **L04** Special colour: **L99**

Articles

SN 9424-03 ALB LED 24V round

Art. no. 810 402

Switch box installation Light colour: 4000 K Protection category: IP20

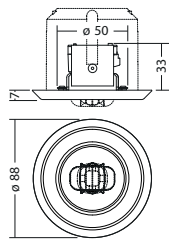

SN 9424-03 ALB LED 24V square

Art. no. 810 406

Switch box installation Light colour: 4000 K Protection category: IP20

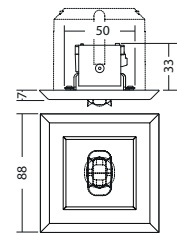



LED safety luminaire with optimised light distribution for the illumination of escape routes with high mounting heights. Also suitable for illumination of firefighting and fire alarm systems as well as first aid stations with 5 lx vertical illuminance.

Recessed ceiling luminaires with powder-coated aluminium trim without visible screws. For installation in Ø 68mm socket. Incl. 4-chip LED illuminant for maximum safety.



Technical data

Material:	Die-cast aluminum powder-coated	Nominal current DC:	110 mA
Illuminant:	LEDs	Protection class:	III
Luminous flux:	287 lm	Input terminals:	2.5mm ² feed through wiring
Nominal voltage DC:	24 V ±20 %	Temperature ta:	-15...+40 °C

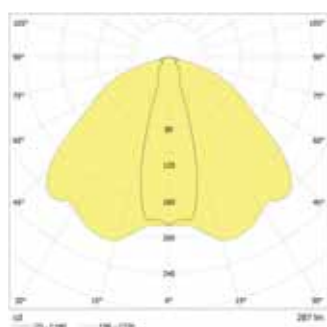

Minimum illumination 1.0 lx (middle of escape route), Maintenance factor 0.8

(m)	1-0	1-1	1-2	1-3
5.0	6.5	16.0	5.8	1.9
6.0	7.0	17.2	5.2	2.1
7.0	7.3	18.4	5.5	2.3
8.0	7.3	19.5	5.8	2.4
9.0	6.8	20.3	6.2	2.4
10.0	6.0	20.7	6.5	2.4
11.0	5.4	20.7	6.7	2.2
12.0	4.2	20.0	6.8	0.7

Available colours Add colour code to the article no. e.g. 800 014 LXX

RAL 9016 (Traffic white): **L04** Special colour: **L99**

Articles

SN 9424-06 AHB LED 24V round

Art. no. 810 403

Switch box installation Light colour: 4000 K Protection category: IP20

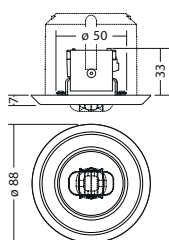

SN 9424-06 AHB LED 24V square

Art. no. 810 407

Switch box installation Light colour: 4000 K Protection category: IP20

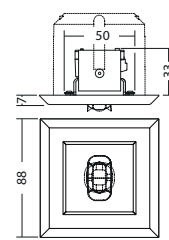



LED safety luminaire with optimised light distribution for the illumination of small areas such as lavatories or electrical operating rooms with a luminaire. Recessed ceiling luminaires with powder-coated aluminium trim without visible screws. For installation in Ø 68mm socket. Incl. 4-chip LED illuminant for maximum safety.

Technical data

Material:	Die-cast aluminum powder-coated	Nominal current DC:	65 mA
Illuminant:	LEDs	Protection class:	III
Luminous flux:	146 lm	Input terminals:	2.5mm ² feed through wiring
Nominal voltage DC:	24 V ±20 %	Temperature ta:	-15...+40 °C

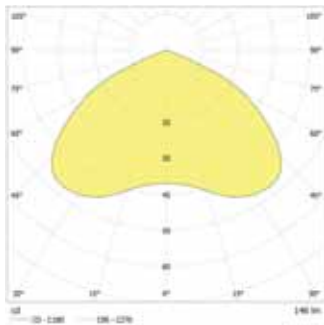

Minimum illumination 1.0 lx (middle of escape route), Maintenance factor 0.8

(m)	2.5	3.3	8.2
	3.0	3.5	8.8
	3.5	3.6	9.4
	4.0	3.5	9.8
	4.5	3.2	10.0
	5.0	2.7	10.1

Minimum illumination 1.0 Lux (area illumination), Maintenance factor 0.8

(m)	2.5	2.2	6.8
	3.0	2.3	7.4
	3.5	2.5	8.0
	4.0	2.6	8.4
	4.5	2.5	8.6
	5.0	2.4	8.2

Available colours Add colour code to the article no. e.g. 800 014 LXX

RAL 9016 (Traffic white): **L04** Special colour: **L99**

Articles

SN 9424-03 SLB LED 24V round

Art. no. 810 408

Switch box installation Light colour: 4000 K Protection category: IP20

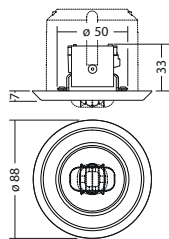

SN 9424-03 SLB LED 24V square

Art. no. 810 410

Switch box installation Light colour: 4000 K Protection category: IP20

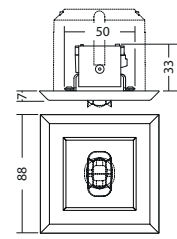

Optional lateral cable entry for surface-mounted installations

The SN 8424 emergency luminaires are available in round and square versions and can therefore be easily integrated into the existing architecture.

The housing offers the possibility of lateral cable entry without additional accessories. The side entries are not visible during normal surface mounting, but can be opened easily if required.





LED safety luminaire with optimised light distribution for the illumination of spaces. Housing made of powder-coated aluminium for ceiling mounting with optional cable entry at the side. Incl. 4-chip LED illuminant for maximum safety.

Technical data

Material:	Die-cast aluminum powder-coated	Nominal current DC:	120 mA
Illuminant:	LEDs	Protection class:	III
Luminous flux:	322 lm	Input terminals:	2.5mm ² feed through wiring
Nominal voltage DC:	24 V ±20 %	Temperature ta:	-15...+40 °C

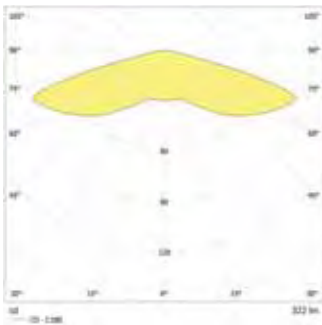

Minimum illumination 1.0 lx (middle of escape route), Maintenance factor 0.8

(m)	2.5	4.7	12.9
2.5	4.7	12.9	
3.0	4.6	13.2	
3.5	4.4	13.3	
4.0	3.8	13.2	
4.5	2.4	12.8	

Minimum illumination 1.0 Lux (area illumination), Maintenance factor 0.8

(m)	2.5	3.7	11.7
2.5	3.7	11.7	
3.0	3.7	12.3	
3.5	3.2	12.8	
4.0	2.9	12.3	
4.5	2.6	12.3	
5.0	2.4	12.3	
5.5	2.2	10.8	
6.0	2.0	9.9	

Available colours Add colour code to the article no. e.g. 800 014 LXX

RAL 9016 (Traffic white): **L04** Special colour: **L99**

Articles

SN 8424-12 SLB LED 24V round

Art. no. 810 380

Ceiling mounting Light colour: 4000 K Protection category: IP40

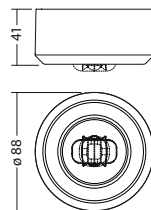

SN 8424-12 SLB LED 24V square

Art. no. 810 384

Ceiling mounting Light colour: 4000 K Protection category: IP40

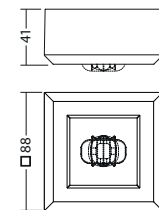

Chain suspension SN 8424 rd, RAL 9016

Art. no. 890 873 L04

optional accessories

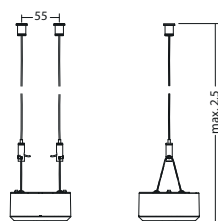

Chain suspension SN 8424 sq, RAL 9016

Art. no. 890 874 L04

optional accessories

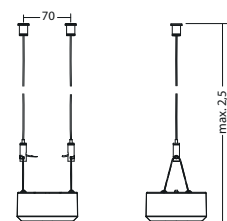



LED safety luminaire with optimised light distribution for the illumination of spaces with high mounting heights. Housing made of powder-coated aluminium for ceiling mounting with optional cable entry at the side. Incl. 4-chip LED illuminant for maximum safety.

Technical data

Material:	Die-cast aluminum powder-coated
Illuminant:	LEDs
Luminous flux:	545 lm
Nominal voltage DC:	24 V \pm 20 %

Nominal current DC:	185 mA
Protection class:	III
Input terminals:	2.5mm ² feed through wiring
Temperature ta:	-15...+40 °C

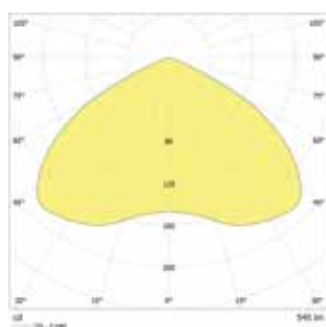

Minimum illumination 1.0 lx (middle of escape route), Maintenance factor 0.8

(m)	6.0	6.9	17.5
6.5	7.0	18.1	
7.0	7.1	18.6	
7.5	7.1	19.0	
8.0	6.9	19.3	
8.5	6.7	19.6	
9.0	6.3	19.8	
9.5	5.8	20.0	
10.0	5.2	20.1	

Minimum illumination 1.0 Lux (area illumination), Maintenance factor 0.8

(m)	6.0	4.9	14.2
6.5	5.1	14.7	
7.0	5.0	14.9	
7.5	4.9	16.2	
8.0	4.7	16.3	
8.5	4.7	16.8	
9.0	4.6	17.5	
9.5	4.5	17.7	
10.0	4.3	16.6	

Available colours Add colour code to the article no. e.g. 800 014 LXX

RAL 9016 (Traffic white): **L04** Special colour: **L99**

Articles

SN 8424-12 SHB LED 24V round

Art. no. 810 381

Ceiling mounting Light colour: 4000 K Protection category: IP40

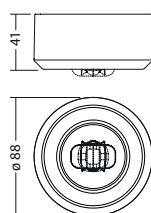

SN 8424-12 SHB LED 24V square

Art. no. 810 385

Ceiling mounting Light colour: 4000 K Protection category: IP40

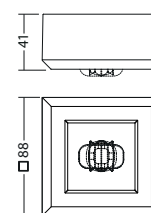

Chain suspension SN 8424 rd, RAL 9016

Art. no. 890 873 L04

optional accessories

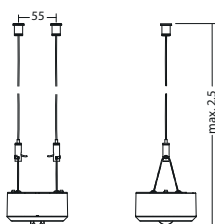

Chain suspension SN 8424 sq, RAL 9016

Art. no. 890 874 L04

optional accessories

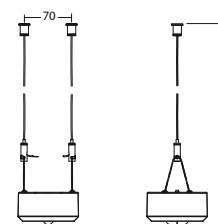



LED safety luminaire with optimised light distribution for the illumination of escape routes. Housing made of powder-coated aluminium for ceiling mounting with optional cable entry at the side. Incl. 4-chip LED illuminant for maximum safety.

Technical data

Material:	Die-cast aluminum powder-coated	Nominal current DC:	65 mA
Illuminant:	LEDs	Protection class:	III
Luminous flux:	139 lm	Input terminals:	2.5mm ² feed through wiring
Nominal voltage DC:	24 V ±20 %	Temperature ta:	-15...+40 °C

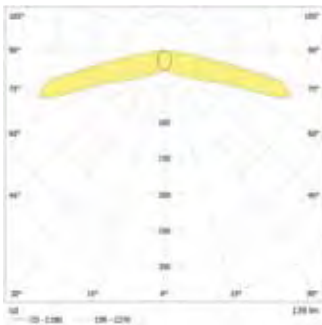

Minimum illumination 1.0 lx (middle of escape route), Maintenance factor 0.8

Beam diameter (m)	Beam diameter (m)	Beam diameter (m)	Beam diameter (m)	Beam diameter (m)
2.5	6.8	17.0	5.3	1.9
3.0	5.3	18.1	5.4	1.8
3.5	4.8	17.9	5.4	1.6
4.0	3.8	17.3	5.3	1.3
4.5	3.0	14.3	5.0	0.9

Available colours Add colour code to the article no. e.g. 800 014 LXX

RAL 9016 (Traffic white): **L04** Special colour: **L99**

Articles

SN 8424-03 ALB LED 24V round

Art. no. 810 382

Ceiling mounting Light colour: 4000 K Protection category: IP40

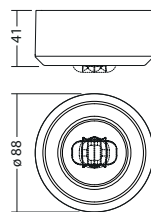

SN 8424-03 ALB LED 24V square

Art. no. 810 386

Ceiling mounting Light colour: 4000 K Protection category: IP40

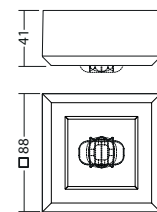

Chain suspension SN 8424 rd, RAL 9016

Art. no. 890 873 L04

optional accessories

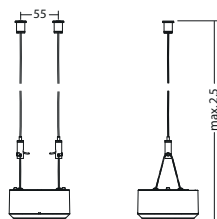

Chain suspension SN 8424 sq, RAL 9016

Art. no. 890 874 L04

optional accessories

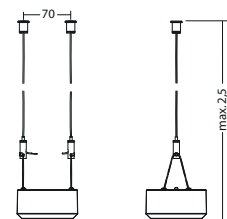



LED safety luminaire with optimised light distribution for the illumination of escape routes with high mounting heights. Also suitable for illumination of firefighting and fire alarm systems as well as first aid stations with 5 lx vertical illuminance. Housing made of powder-coated aluminium for ceiling mounting with optional cable entry at the side. Incl. 4-chip LED illuminant for maximum safety.



Technical data

Material:	Die-cast aluminum powder-coated	Nominal current DC:	110 mA
Illuminant:	LEDs	Protection class:	III
Luminous flux:	287 lm	Input terminals:	2.5mm ² feed through wiring
Nominal voltage DC:	24 V ±20 %	Temperature ta:	-15...+40 °C

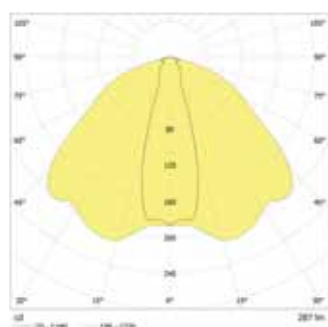

Minimum illumination 1.0 lx (middle of escape route), Maintenance factor 0.8

(m)	⊖	⊖	⊖	⊖
5.0	6.5	16.0	5.8	1.9
6.0	7.0	17.2	5.2	2.1
7.0	7.3	18.4	5.5	2.3
8.0	7.3	19.5	5.8	2.4
9.0	6.8	20.3	6.2	2.4
10.0	6.0	20.7	6.5	2.4
11.0	5.4	20.7	6.7	2.2
12.0	4.2	20.0	6.8	0.7

Available colours Add colour code to the article no. e.g. 800 014 **LXX**

RAL 9016 (Traffic white): **L04** Special colour: **L99**

Articles

SN 8424-06 AHB LED 24V round Art. no. 810 383

Ceiling mounting Light colour: 4000 K Protection category: IP40

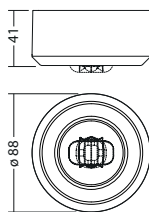

SN 8424-06 AHB LED 24V square Art. no. 810 387

Ceiling mounting Light colour: 4000 K Protection category: IP40

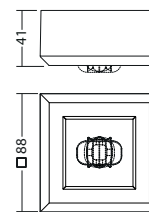

Chain suspension SN 8424 rd, RAL 9016 Art. no. 890 873 L04

optional accessories

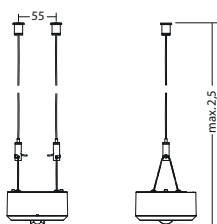

Chain suspension SN 8424 sq, RAL 9016 Art. no. 890 874 L04

optional accessories

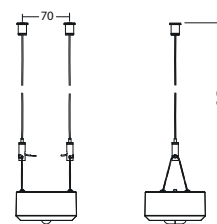



LED safety luminaire with optimised light distribution for the illumination of small areas such as lavatories or electrical operating rooms with a luminaire. Housing made of powder-coated aluminium for ceiling mounting with optional cable entry at the side. Incl. 4-chip LED illuminant for maximum safety.

Technical data

Material:	Die-cast aluminum powder-coated
Illuminant:	LEDs
Luminous flux:	146 lm
Nominal voltage DC:	24 V ±20 %

Nominal current DC:	65 mA
Protection class:	III
Input terminals:	2.5mm ² feed through wiring
Temperature ta:	-15...+40 °C

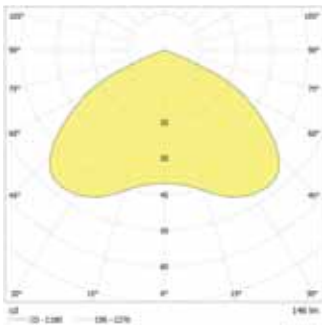

Minimum illumination 1.0 lx (middle of escape route), Maintenance factor 0.8

(m)	⊘	⊘
2.5	3.3	8.2
3.0	3.5	8.8
3.5	3.6	9.4
4.0	3.5	9.8
4.5	3.2	10.0
5.0	2.7	10.1

Minimum illumination 1.0 Lux (area illumination), Maintenance factor 0.8

(m)	⊘	⊘
2.5	2.2	6.8
3.0	2.3	7.4
3.5	2.5	8.0
4.0	2.6	8.4
4.5	2.5	8.6
5.0	2.4	8.2

Available colours Add colour code to the article no. e.g. 800 014 **LXX**

RAL 9016 (Traffic white): **L04** Special colour: **L99**

Articles

SN 8424-03 SLB LED 24V round Art. no. 810 388

Ceiling mounting Light colour: 4000 K Protection category: IP40

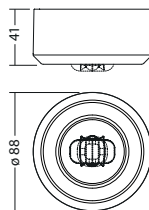

SN 8424-03 SLB LED 24V square Art. no. 810 390

Ceiling mounting Light colour: 4000 K Protection category: IP40

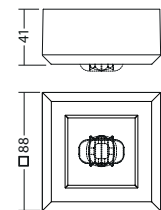

Chain suspension SN 8424 rd, RAL 9016 Art. no. 890 873 L04

optional accessories

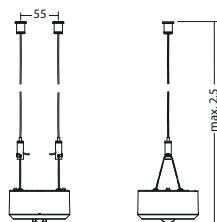

Chain suspension SN 8424 sq, RAL 9016 Art. no. 890 874 L04

optional accessories

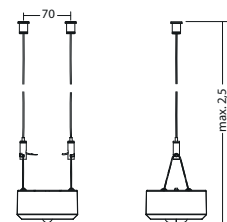



Performance-optimised illumination of large areas

The SN 8500-08 SHB is excellently suitable for illuminating large areas with an illuminance of one lux.

Secondary optics with rotationally symmetrical light distribution enable effective and homogeneous illumination.

The highly efficient LED illuminant with a luminous flux of more than 160lm/W ensures significant luminaire spacing between luminaires for large mounting heights.

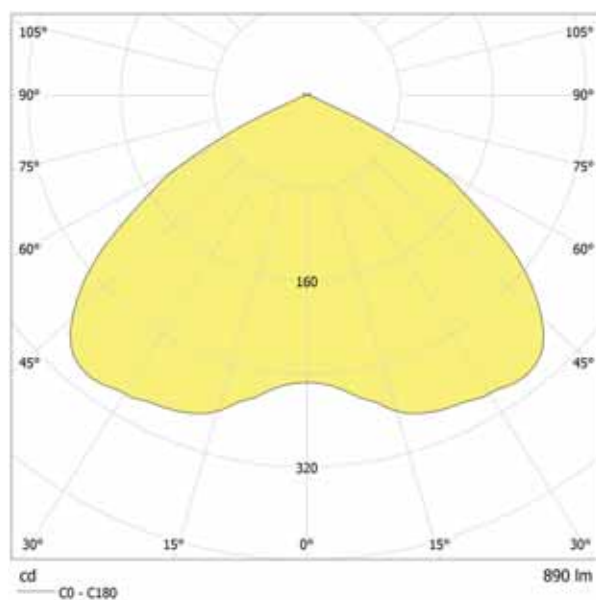



The robust powder-coated die-cast aluminium housing of the SN 8500 is ideally suited for use in industry. The luminaire is protected against the ingress of water and dust by the high protection degree of IP65.

In addition to the cable entries from behind, the housing also offers the option of inserting cable glands laterally into the housing. For this purpose, two pre-embossed openings can simply be removed on each of the three sides.

Optional accessories allow the luminaire to be mounted flexibly. The SN 8500 can be suspended on chains, mounted on the wall with a lockable wall bracket or installed in the ceiling with a mounting frame.

Case study

Project:	Industrial hall			
Mounting:	Ceiling mounting (12m height)			
Hall size:	50m x 32m (1600m ²)			
Illumination level:	E_{min} : 1lx			
Maintenance factor:	0,8			
Luminaires:	Quantity	Type	I_{Batt}	Sum I_{Batt}
	6	SN 8500-08 SHB LED 24V (1)	430mA	2.58A
	4	SNP 7188 LED 24V (2)	115mA	0.46A
	4	SNP 2420 LED 24V (3)	115mA	0.46A
	4	SN 6204 LED 24V (4)	150mA	0.60A
				4,10A

Emergency lighting system: 1 x CLS FUSION – 12Ah

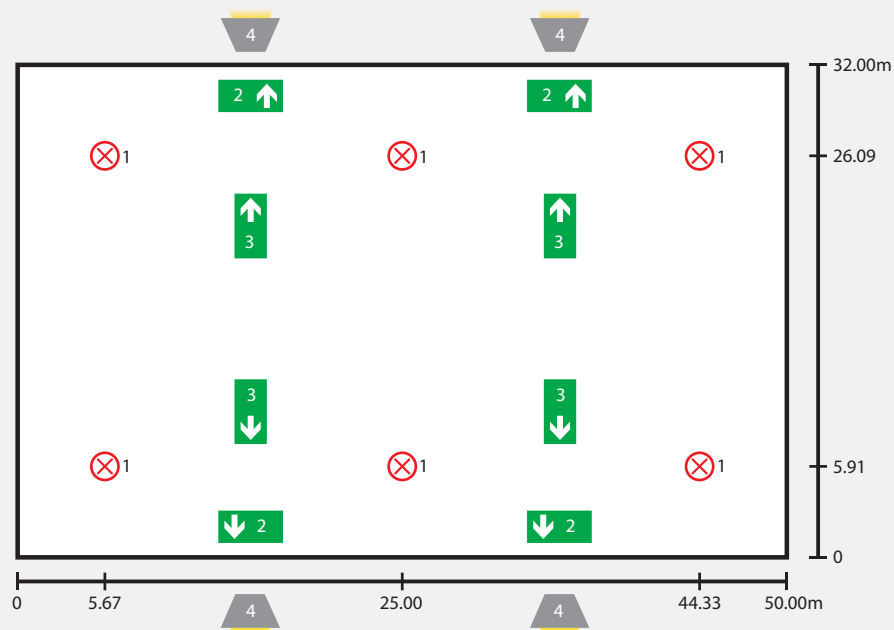

This project example shows a 1600m² large industrial hall with a light point height of 12m. The area can be illuminated with one Lux by only 6 luminaires over the entire area. In addition, four one-sided escape sign luminaires SNP 7188 LED 24V and four four-sided escape sign luminaires SNP 2420 LED 24V are used to indicate escape routes. One SN 6204.2 LED 24V IP65 emergency luminaire is located above each outer door to illuminate the outdoor area.

All emergency luminaires are supplied by a decentralised emergency lighting unit CLS FUSION - 12Ah.



Downlight for enhanced lighting requirements. For illuminating large areas with high mounting heights. Robust housing made of die-cast aluminium with optional lateral cable gland.



Technical data

Material:	Die-cast aluminum
Illuminant:	LEDs
Luminous flux:	801 lm
Nominal voltage DC:	24 V ±25 %
Nominal current DC:	430 mA

Protection class:	I
Input terminals:	2.5mm ² feed through wiring
Temperature ta:	-15...+40 °C
Impact resistance:	IK10

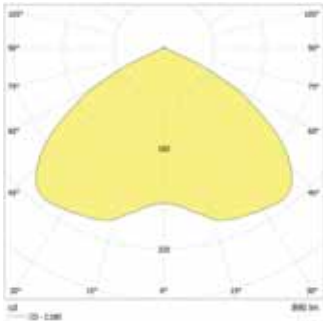

Minimum illumination 1.0 lx (middle of escape route), Maintenance factor 0.8

[m]	3.0	5.5	12.2
3.0	4.0	6.5	15.1
4.0	5.0	7.2	17.4
5.0	6.0	7.8	19.0
6.0	7.0	8.2	20.4
7.0	8.0	8.4	21.5
8.0	9.0	8.4	22.5
9.0	10.0	8.1	23.5
10.0	11.0	7.4	23.8
11.0	12.0	6.5	23.9
12.0	13.0	5.2	23.7

Minimum illumination 1.0 Lux (area illumination), Maintenance factor 0.8

[m]	4.0	4.8	11.5
4.0	6.0	5.5	15.4
5.0	8.0	5.8	18.2
6.0	10.0	5.8	20.1
7.0	12.0	5.5	21.5
8.0	14.0	5.4	21.7
9.0	16.0	4.0	19.5
10.0	18.0	3.5	15.9
11.0	20.0	3.0	14.7
12.0	22.0	3.0	12.7
13.0	24.0	2.5	10.8

Available colours Add colour code to the article no. e.g. 800 014 LXX

RAL 9006 (White aluminium): **L10** ■ Special colour: **L99** ■

Articles

SN 8500-08 SHB LED 24V Art. no. 810 392

Ceiling mounting Light colour: 4000 K Protection category: IP65

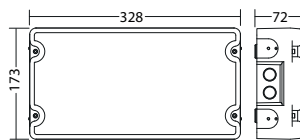

Recessed ceiling frame SN 8500, RAL 9006 Art. no. 890 401 L10

optional accessories

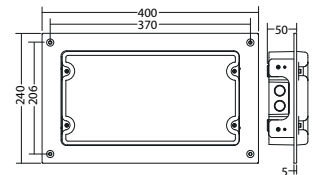

Wall bracket SN 8500, RAL 9006 Art. no. 890 402 L10

optional accessories

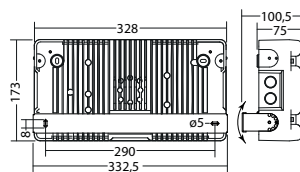

Ringbolts for SN 8500/24xx Art. no. 890 403

optional accessories

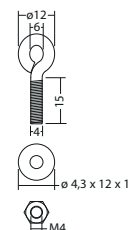

Elegant aluminium surface-mounted downlight for inside and out

Its modern design and high IP65 protection category mean the new surface-mounted spotlight SN 8040 is ideal for both prestigious and functional areas.

As with all of INOTEC's new developments, this luminaire makes use of the most up-to-date lighting technology. And you have a choice of the new INOTEC TES light source or a 4x1W LED light source.

The housing, made of high-quality aluminium, has not only an eye-catching design but also offers enough connection room for fast and easy installation.

Thanks to the high-quality powder coatings used by INOTEC, the SN 8040 can be coloured to match the architecture. All the RAL colours can be recreated in a stylish, structured finish.

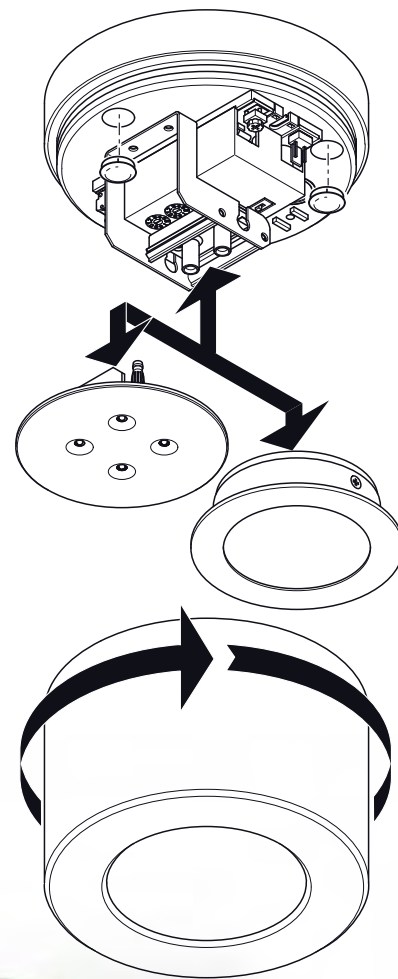



Elegant high-quality LED downlight ideal for area or escape route illumination. Powder-coated aluminium housing for ceiling mounting with high protection category and without any visible screws.

Technical data

Material:	Aluminium powder-coated	Nominal current DC:	200 mA
Illuminant:	LEDs	Protection class:	I
Luminous flux:	310 lm	Input terminals:	2.5mm ² feed through wiring
Nominal voltage DC:	24 V ±25 %	Temperature ta:	-15...+40 °C

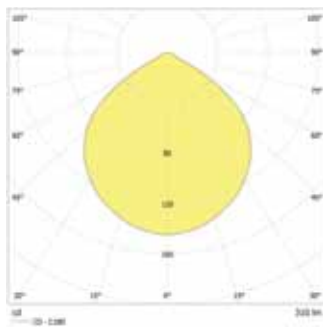

Minimum illumination 1.0 lx (middle of escape route), Maintenance factor 0.8

(m)	2.5	3.7	8.5
2.5	3.7	4.1	9.7
3.0	4.1	4.7	11.5
4.0	4.7	5.0	12.9
5.0	5.0	5.1	13.9
6.0	4.9	4.5	14.4
7.0	4.5	3.7	14.3
8.0	3.7	2.5	13.8
9.0	2.5		
10.0			

Minimum illumination 1.0 Lux (area illumination), Maintenance factor 0.8

(m)	2.5	2.7	6.4
2.5	2.7	3.1	7.3
3.0	3.1	3.6	9.0
4.0	3.6	3.7	10.6
5.0	3.7	3.7	11.8
6.0	3.6	3.4	12.4
7.0	3.4	3.1	12.6
8.0	3.1	2.6	12.4
9.0	2.6		
10.0			

Available colours Add colour code to the article no. e.g. 800 014 **LXX**

RAL 7015 (Slate grey): **L16** ■ RAL 9016 (Traffic white): **L04** □ Special colour: **L99** 🌈

Articles

SN 8040-41 LED 24V

Art. no. 810 306

Ceiling mounting

Protection category: IP65

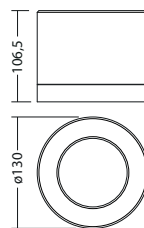



Elegant high-quality LED downlight ideal for area or escape route illumination. Perfect for combined usage of safety and general lighting. Possible adaption to the light colour of the general lighting by Translucent-Emitting-Surface (TES) technology. Powder-coated aluminium housing for ceiling mounting with high protection category and without any visible screws.

Technical data

Material:	Aluminium powder-coated	Nominal current DC:	200 mA
Illuminant:	LEDs	Protection class:	I
Luminous flux:	261 lm	Input terminals:	2.5mm ² feed through wiring
Nominal voltage DC:	24 V ±25 %	Temperature ta:	-15...+40 °C

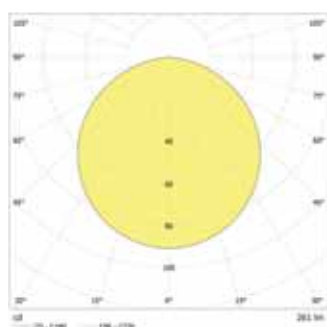

Minimum illumination 1.0 lx (middle of escape route), Maintenance factor 0.8

(m)	3.7	9.4
2.5	3.8	10.1
3.0	4.1	11.0
4.0	4.1	11.6
5.0	3.8	11.7
6.0		

Minimum illumination 1.0 Lux (area illumination), Maintenance factor 0.8

(m)	2.5	8.0
2.5	2.7	8.6
3.0	2.7	9.8
4.0	2.7	10.6
5.0	2.7	10.6
6.0		

Available colours Add colour code to the article no. e.g. 800 014 **LXX**

RAL 7015 (Slate grey): **L16** ■ RAL 9016 (Traffic white): **L04** □ Special colour: **L99** 🌈

Articles

SN 8040 LED 24V

Art. no. 810 307

Ceiling mounting Light colour: 2700 K Protection category: IP65

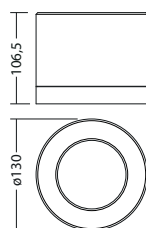

SN 8040 LED 24V

Art. no. 810 308

Ceiling mounting Light colour: 3500 K Protection category: IP65

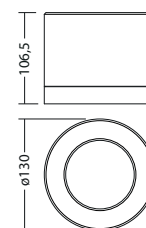

SN 8040 LED 24V

Art. no. 810 309

Ceiling mounting Light colour: 4300 K Protection category: IP65

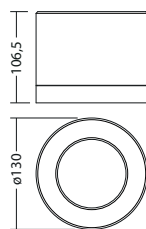



Elegant high-quality LED downlight ideal for area or escape route illumination. Powder-coated aluminium housing for ceiling mounting with high protection category and without any visible screws.

Technical data

Illuminant:	LEDs	Protection class:	III
Luminous flux:	87 lm	Input terminals:	2.5mm ² feed through wiring
Nominal voltage DC:	24 V ±20 %	Temperature ta:	-15...+40 °C
Nominal current DC:	80 mA		

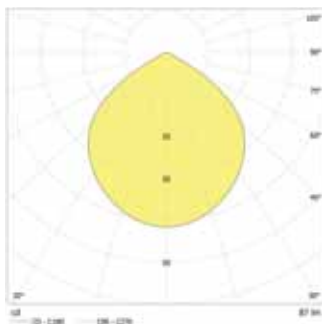

Minimum illumination 1.0 lx (middle of escape route), Maintenance factor 0.8

Distance (m)	Beam diameter (m)	Beam diameter (ft)
2.0	2.2	5.4
2.5	2.4	6.2
3.0	2.5	6.8
3.5	2.5	7.2
4.0	2.3	7.4
4.5	2.0	7.4
5.0	1.6	7.2
5.5	0.7	7.0

Minimum illumination 1.0 Lux (area illumination), Maintenance factor 0.8

Distance (m)	Beam diameter (m)	Beam diameter (ft)
2.5	2.0	5.3
3.0	2.1	5.8
4.0	1.8	6.1
5.0	1.7	6.1
6.0	1.4	5.8

Available colours Add colour code to the article no. e.g. 800 014 **LXX**

RAL 9016 (Traffic white): **L04** Special colour: **L99**

Articles

SN 8106-11 LED 24V

Art. no. 810 214

Ceiling mounting

Protection category: IP65

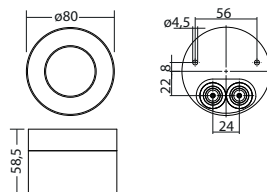



Ball-impact-proof and shock-resistant luminaires

The robust, ball-impact-proof and shock-resistant safety and exit sign luminaires are not only suitable for use in gyms and sports halls, but can also be used wherever luminaires are exposed to increased mechanical loads.

The luminaires are designed to pass the pendulum hammer test according to EN 50102 without any problems. All luminaires in this series comply with impact resistance class IK10. In addition, the luminaires passed a ball impact test in accordance with DIN VDE 0710-13. This eliminates the need for additional ball protection grids.

Despite these high requirements, these luminaires impress with their slim design and homogeneous illumination, which also makes them suitable for use in visually attractive buildings.

Advantages

- Easy installation
- Ball-impact-proof according to DIN VDE 0710-13
- Shock-resistant class IK10
- Slim Design

Applications

- Gym and sportshalls
- Schools
- Workplaces with higher mechanical demands



Ball-impact-proof luminaires
acc. to to DIN VDE 0710-13



SNP 8030

178



SN 8030

182



Single sided ball-impact and shock resistant exit luminaire. Powder-coated aluminium housing with slim design and brilliant pictograph illumination > 500cd/m². Perfect for use in environments with high mechanical stresses and in sports facilities.



IK10

Technical data

Viewing distance:	30 m	Protection class:	III
Material:	Sheet steel powder-coated	Input terminals:	2.5mm ² feed through wiring
Illuminant:	LEDs	Temperature ta:	-15...+40 °C
Nominal voltage DC:	24 V ±20 %	Impact resistance:	IK10
Nominal current DC:	115 mA		

Available colours Add colour code to the article no. e.g. 800 014 LXX

RAL 9016 (Traffic white): **L04** RAL 7015 (Slate grey): **L16** Special colour: **L99**

Articles

SNP 8030 LED 24V

Art. no. 810 179

Wall mounting

Protection category: IP40

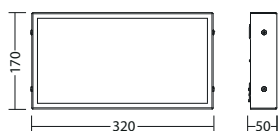

SNP 8030 WE LED 24V

Art. no. 810 180

Recessed wall mounting

Protection category: IP40

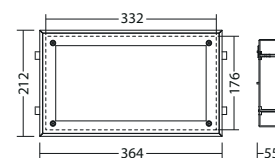



Double-sided ball-impact and shock resistant exit-luminaire. Powder-coated metal housing with slim design and brilliant pictograph illumination > 500cd/m². Perfect for use in environments with high mechanical stresses and in sports facilities.



Technical data

Viewing distance:	30 m	Protection class:	III
Material:	Sheet steel powder-coated	Input terminals:	2.5mm ² feed through wiring
Illuminant:	LEDs	Temperature ta:	-15...+40 °C
Nominal voltage DC:	24 V ±20 %	Impact resistance:	IK10
Nominal current DC:	200 mA		

Available colours Add colour code to the article no. e.g. 800 014 **LXX**

RAL 9016 (Traffic white): **L04** RAL 7015 (Slate grey): **L16** Special colour: **L99**

Articles

SNP 8030 D LED 24V

Art. no. 810 181

Ceiling mounting

Protection category: IP40

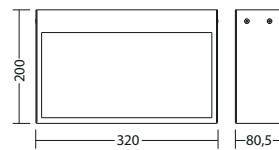







Ball-impact and shock resistant safety luminaires with state-of-the-art LED-technology for area or escape route illumination. Powder-coated aluminium housing with slim design, perfect for use in environments with high mechanical stresses and in sports facilities.



Technical data

Material:	Sheet steel powder-coated
Illuminant:	LEDs
Luminous flux:	310 lm
Nominal voltage DC:	24 V ±20 %
Nominal current DC:	200 mA

Protection class:	III
Input terminals:	2.5mm ² feed through wiring
Temperature ta:	-15...+40 °C
Impact resistance:	IK10

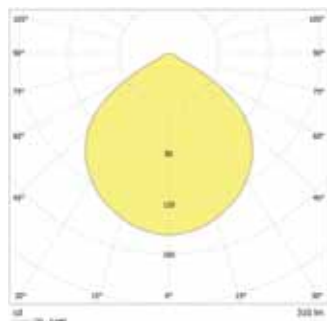

Minimum illumination 1.0 lx (middle of escape route), Maintenance factor 0.8

Distance [m]	Beam diameter [m]	Beam diameter [m]
2.5	3.7	8.5
3.0	4.1	9.7
4.0	4.7	11.5
5.0	5.0	12.9
6.0	5.1	13.9
7.0	4.9	14.3
8.0	4.5	14.4
9.0	3.7	14.3
10.0	2.5	13.8

Minimum illumination 1.0 Lux (area illumination), Maintenance factor 0.8

Distance [m]	Beam diameter [m]	Beam diameter [m]
2.5	2.7	6.4
3.0	3.1	7.3
4.0	3.6	9.0
5.0	3.7	10.6
6.0	3.7	11.8
7.0	3.6	12.4
8.0	3.4	12.8
9.0	3.1	12.6
10.0	2.6	12.4

Available colours Add colour code to the article no. e.g. 800 014 LXX

RAL 9016 (Traffic white): **L04** RAL 7015 (Slate grey): **L16** Special colour: **L99**

Articles

SN 8030 AP LED 24V

Art. no. 810 311

ceiling mounting for exposed wiring

Protection category: IP40

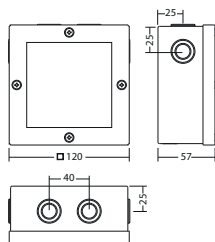

SN 8030 D LED 24V

Art. no. 810 310

Ceiling mounting

Protection category: IP40

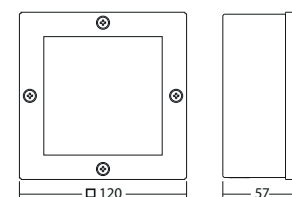

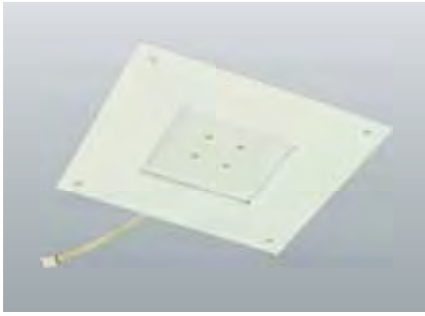

Ball-impact and shock resistant safety luminaires with state-of-the-art LED-technology for area or escape route illumination. Powder-coated aluminium housing with slim design, perfect for use in environments with high mechanical stresses and in sports facilities.



Technical data

Material:	Sheet steel powder-coated
Illuminant:	LEDs
Luminous flux:	310 lm
Nominal voltage DC:	24 V ±20 %
Nominal current DC:	200 mA

Protection class:	III
Input terminals:	2.5mm ² feed through wiring
Temperature ta:	-15...+40 °C
Impact resistance:	IK10

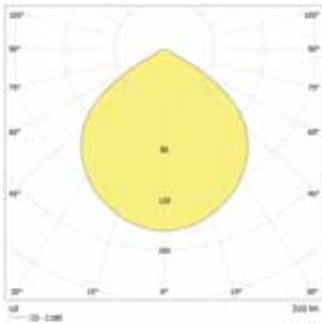

Minimum illumination 1.0 lx (middle of escape route), Maintenance factor 0.8

[m]	2.5	3.7	8.5
2.5	3.7	4.1	9.7
3.0	4.7	5.1	13.9
4.0	5.0	4.9	14.3
5.0	5.1	4.5	14.4
6.0	3.7	3.7	14.3
7.0	2.5	2.5	13.8
8.0	2.5	2.5	13.8
9.0	2.5	2.5	13.8
10.0	2.5	2.5	13.8

Minimum illumination 1.0 Lux (area illumination), Maintenance factor 0.8

[m]	2.5	2.7	6.4
2.5	3.1	3.1	7.3
3.0	3.6	3.6	9.0
4.0	3.7	3.7	10.6
5.0	3.7	3.7	11.8
6.0	3.6	3.6	12.4
7.0	3.4	3.4	12.8
8.0	3.1	3.1	12.6
9.0	2.6	2.6	12.4
10.0	2.6	2.6	12.4

Available colours Add colour code to the article no. e.g. 800 014 LXX

RAL 9016 (Traffic white): **L04** RAL 7015 (Slate grey): **L16** Special colour: **L99**

Articles

SN 8030 E LED 24V

Art. no. 808 711

Recessed ceiling mounting



Protection category: IP20

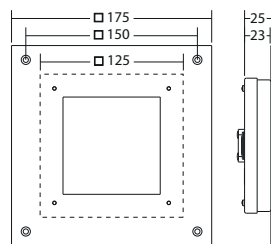

LED-supply 24-3 SK III ext.

Art. no. 890 613

required

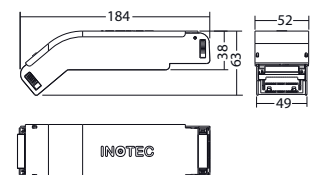



Moulded plastic luminaires

Universal emergency exit and safety luminaires



INOTEC offers a wide range of moulded plastic luminaires. The different housing sizes and versions allow you to personalise your emergency lighting. The range includes luminaires with one-, two- or three-sided light output, as well as luminaires with a high protection rating.

Advantages

- Different housing sizes
- Protection ratings up to IP65

Areas of application

- Workplaces
- Car parks
- Outdoor areas

	SNP 2130/2230	191
	SN 2100	194
	SN 2100 ECO	198



Moulded plastic luminaires, made in Germany

The new moulded plastic luminaires

SN 2100, SN(P) 2130 and SNP 2230 were designed and constructed completely in house.

A close collaboration with our customers, designers and fitters allowed us to take into account requests and suggestions during the construction phase, so we have been able to satisfy all the demands placed on a modern moulded plastic luminaire.

The polycarbonate housing and all other components are produced in Germany. This guarantees that they meet the high standards for products Made in Germany.

With its optimised lighting technology, the SN 2100 LED is ideal not just for illuminating escape routes and open (anti-panic) areas, but also for illuminating halls or high-bay warehouses with high mounting heights.



Numerous mounting options thanks to the optional mounting adapter

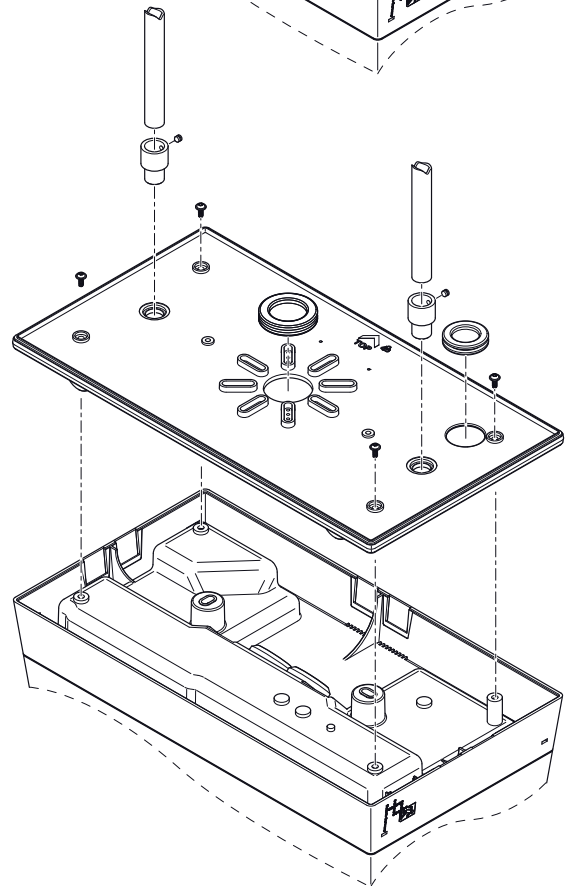
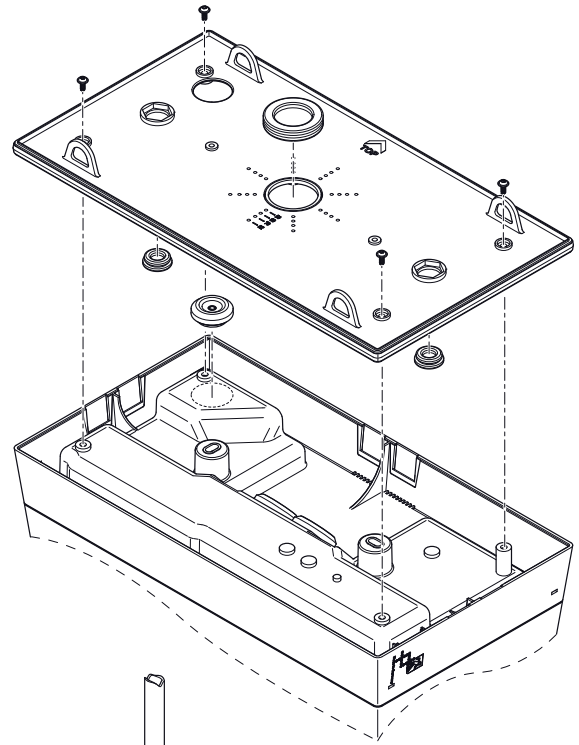
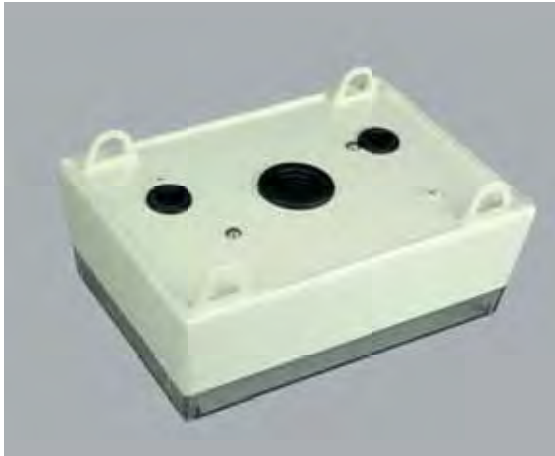



PC II



IP 65



UV resistant



The high degree of protection and the protective-insulated housing allow use in difficult ambient conditions.

The luminaires are made of high-quality UV and glow-wire resistant polycarbonate and are available in IP 40 and IP 65 protection classes.

Even with lateral cable entry, the encapsulated connection compartment guarantees protection class II and the high degree of protection IP65.



Easy to mount in both on-wall and in-wall installation

Quick to install in five easy steps

1. Install luminaire housing
2. Connect power cable
3. Fit illuminant
4. Click reflector into place
5. Close cover

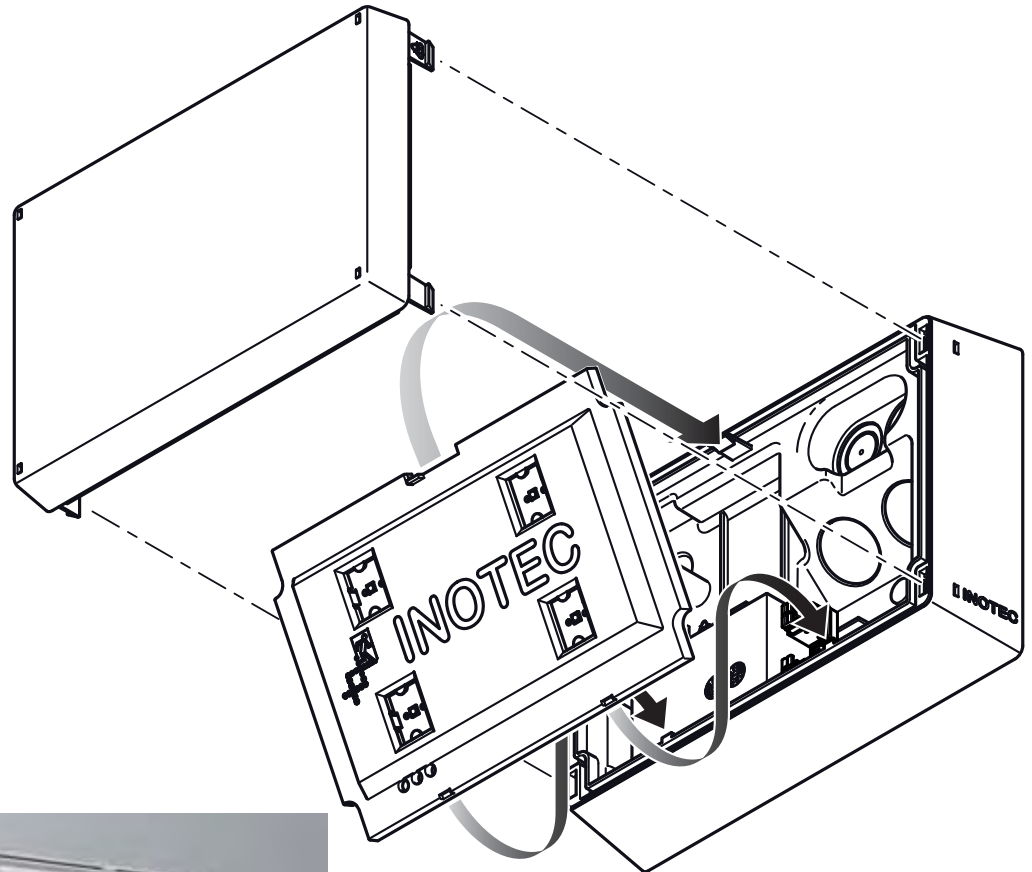

With on-wall installations, pre-moulded lateral openings can simply be punched out. A cable inlet ensures the power cable is inserted cleanly. The separate terminal compartment inside the luminaire further guarantees the high protection rating IP65. There are two mouldings on each of three sides of the luminaire, so that through-wiring is also possible.

A slightly raised surface on the back of the luminaires ensures that they can be mounted on uneven walls without compromising their tightness. The luminaires' special construction ensures there is no warping, which often leads to leaks in conventional housing constructions. The optional adapter for chain and pendulum mounting is also perfect for installation on trapezoidal sheets and rail systems.



3.01/S06

INOTEC



Single sided LED exit luminaire made of UV resistant, heat filament tested polycarbonate housing with optional side cable entry and comfortable installation space. Homogeneous illumination by state-of-the-art LED technology.



Technical data

Viewing distance:	30 m	Nominal current DC:	200 mA
Material:	Polycarbonate	Protection class:	III
Illuminant:	LEDs	Input terminals:	2.5mm ² feed through wiring
Nominal voltage DC:	24 V ±20 %	Temperature ta:	-15...+40 °C

Articles

SNP 2130 LED 24V

Art. no. 810 302

Wall mounting

Protection category: IP40

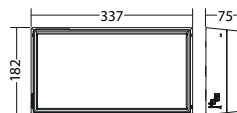

SNP 2130 LED 24V

Art. no. 810 303

Wall mounting

Protection category: IP65

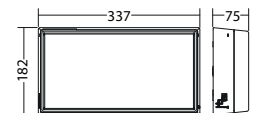





Double-sided LED emergency exit luminaire made of UV resistant, heat filament tested polycarbonate housing with optional side cable entry and comfortable installation space. Homogeneous illumination by state-of-the-art LED technology.

Technical data

Viewing distance:	30 m	Nominal current DC:	200 mA
Material:	Polycarbonate	Protection class:	III
Illuminant:	LEDs	Input terminals:	2.5mm ² feed through wiring
Nominal voltage DC:	24 V ±20 %	Temperature ta:	-15...+40 °C

Articles

SNP 2230 LED 24V Art. no. 810 304

Ceiling mounting

Protection category: IP40

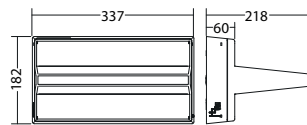

SNP 2230 LED 24V Art. no. 810 305

Ceiling mounting

Protection category: IP65

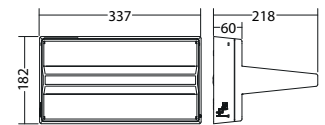

chain mounting adapter SN 2130 Art. no. 890 051

optional accessories

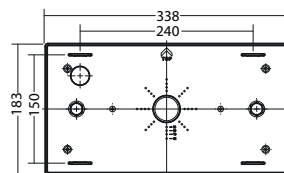

pendulum mounting adapter SN 2130 Art. no. 890 052

optional accessories

Protection category: IP40

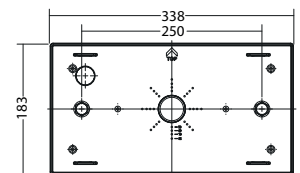



Universal LED downlight ideal for area or escape route illumination. UV resistant, heat filament tested polycarbonate housing with optional side cable entry and comfortable installation space.

Technical data

Material:	Polycarbonate
Illuminant:	LEDs
Luminous flux:	338 lm
Nominal voltage DC:	24 V ±20 %

Nominal current DC:	200 mA
Protection class:	III
Input terminals:	2.5mm ² feed through wiring
Temperature ta:	-15...+40 °C

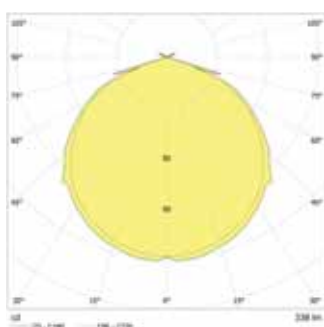

Minimum illumination 1.0 lx (middle of escape route), Maintenance factor 0.8

(m)	4.0	10.0	10.3	4.0
2.5	4.0	10.0	10.3	4.0
3.0	4.3	10.8	11.0	4.3
4.0	4.6	12.0	12.3	4.8
5.0	4.7	12.8	13.1	4.9
6.0	4.6	13.2	13.7	4.9
7.0	4.3	13.4	13.9	4.4
8.0	3.7	13.3	13.9	3.8
9.0	2.5	13.0	13.3	2.7
10.0	1.7	12.1	12.9	1.9

Minimum illumination 1.0 Lux (area illumination), Maintenance factor 0.8

(m)	2.7	8.4	8.5	2.7
2.5	2.7	8.4	8.5	2.7
3.0	2.9	9.1	9.2	2.9
4.0	3.0	10.4	10.5	3.0
5.0	3.0	11.5	11.6	3.0
6.0	3.0	12.3	12.4	3.0
7.0	3.2	12.5	12.6	3.2
8.0	3.1	12.5	12.6	3.1
9.0	2.8	12.2	12.1	2.8
10.0	2.3	12.0	12.1	2.3

Articles

SN 2100 LED 24V

Art. no. 810 200

Ceiling mounting

Protection category: IP40

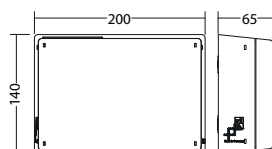

SN 2100 LED 24V

Art. no. 810 201

Ceiling mounting

Protection category: IP65

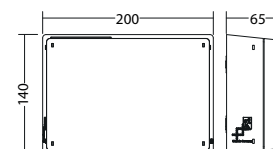

chain mounting adapter SN 2100

Art. no. 890 724

optional accessories

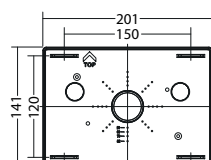



Universal LED downlight ideal for escape route illumination. UV resistant, heat filament tested polycarbonate housing with optional side cable entry and comfortable installation space.

Technical data

Material:	Polycarbonate
Illuminant:	LEDs
Luminous flux:	281 lm
Nominal voltage DC:	24 V ±20 %

Nominal current DC:	200 mA
Protection class:	III
Input terminals:	2.5mm ² feed through wiring
Temperature ta:	-15...+40 °C

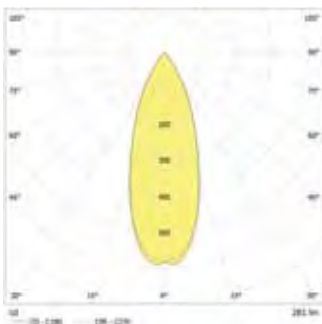

Minimum illumination 1.0 lx (middle of escape route), Maintenance factor 0.8

(m)	4.3	4.5	4.7	4.9	5.1
8.0	4.3	10.3	10.4	4.4	
9.0	4.5	11.0	11.1	4.6	
10.0	4.7	11.7	11.8	4.7	
11.0	4.7	12.2	12.3	4.7	
12.0	4.7	12.7	12.7	4.7	
13.0	4.7	13.0	13.1	4.7	
14.0	4.6	13.2	13.3	4.7	
15.0	4.5	13.4	13.5	4.6	
16.0	4.4	13.5	13.5	4.5	
17.0	4.2	13.5	13.5	4.3	
18.0	3.9	13.4	13.5	4.0	
19.0	3.5	13.3	13.4	3.6	
20.0	2.9	13.2	13.3	3.1	

Minimum illumination 1.0 Lux (area illumination), Maintenance factor 0.8

(m)	3.5	9.5	9.5	3.6
10.0	3.5	10.1	10.1	3.5
11.0	3.5	10.5	10.5	3.5
12.0	3.5	11.1	11.1	3.5
13.0	3.4	11.5	11.5	3.4
14.0	3.2	11.8	11.8	3.2
15.0	3.2	11.8	11.8	3.2
16.0	3.1	12.0	12.0	3.1
17.0	3.0	12.0	12.0	3.0
18.0	2.9	11.8	11.8	2.9
19.0	2.7	11.3	11.3	2.7
20.0				

Articles

SN 2100 T LED 24V Art. no. 810 204

Ceiling mounting

Protection category: IP40

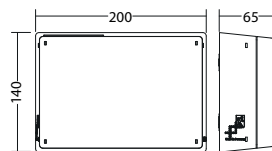

SN 2100 T LED 24V Art. no. 810 205

Ceiling mounting

Protection category: IP65

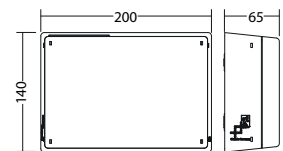

chain mounting adapter SN 2100 Art. no. 890 724

optional accessories

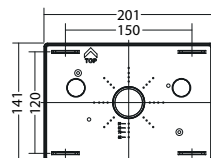





Universal LED downlight for mounting height up to 18m, ideal for illumination of 3m – 4m wide escape routes. UV resistant, heat filament tested polycarbonate housing with optional side cable entry and comfortable installation space.

Technical data

Material:	Polycarbonate	Nominal current DC:	200 mA
Illuminant:	LEDs	Protection class:	III
Luminous flux:	329 lm	Input terminals:	2.5mm ² feed through wiring
Nominal voltage DC:	24 V ±20 %	Temperature ta:	-15...+40 °C

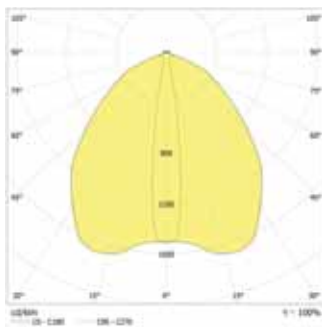

Minimum illumination 1.0 lx (middle of escape route), Maintenance factor 0.8

Mounting height [m]	Beam diameter [m]	Beam diameter [m]	Maximum escape route width for area illumination with 1.25lx
8.0	7.1	18.0	
9.0	7.6	20.5	
10.0	8.0	21.6	
11.0	8.2	22.5	
12.0	7.0	21.1	
13.0	7.1	22.2	
14.0	7.1	22.6	
15.0	7.0	23.3	
16.0	7.4	24.6	
17.0	6.8	24.7	
18.0	6.4	24.6	

Articles

SN 2100 TB LED 24V

Art. no. 810 217

Ceiling mounting

Protection category: IP40

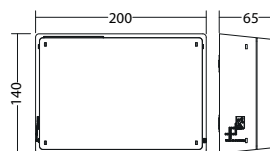

SN 2100 TB LED 24V

Art. no. 810 216

Ceiling mounting

Protection category: IP65

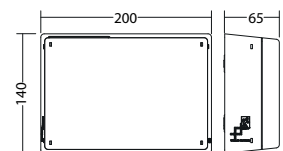

chain mounting adapter SN 2100

Art. no. 890 724

optional accessories

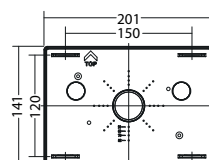



Universal LED downlight ideal for area or escape route illumination. UV resistant, heat filament tested polycarbonate housing with optional side cable entry and comfortable installation space.

Technical data

Material:	Polycarbonate
Illuminant:	LEDs
Luminous flux:	152 lm
Nominal voltage DC:	24 V ±20 %

Nominal current DC:	90 mA
Protection class:	III
Input terminals:	2.5mm ² feed through wiring
Temperature ta:	-15...+40 °C

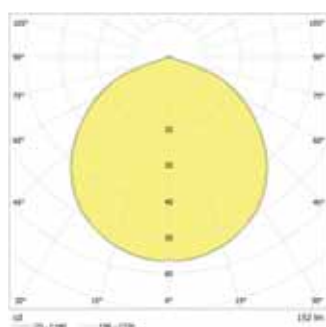

Minimum illumination 1.0 lx (middle of escape route), Maintenance factor 0.8

(m)	2.0	2.5	3.0	3.5	4.0	4.5	5.0	5.5	6.0
2.9	2.9	3.1	3.2	3.3	3.1	2.9	2.6	2.1	
7.3	7.3	8.0	8.5	8.8	9.1	9.2	9.2	9.1	
7.2	7.2	7.9	8.4	8.8	9.1	9.1	9.2	9.1	
2.8	2.8	3.0	3.2	3.3	3.2	3.1	3.0	2.6	2.1

Minimum illumination 1.0 Lux (area illumination), Maintenance factor 0.8

(m)	2.5	3.0	4.0	5.0	6.0
2.1	2.1	2.1	2.1	2.0	1.9
6.7	6.7	7.3	8.2	8.7	8.8
6.8	6.8	7.4	8.3	8.8	8.9
2.2	2.2	2.1	2.1	2.0	1.9

Articles

SN 2100 ECO LED 24V

Art. no. 810 229

Ceiling mounting

Protection category: IP40

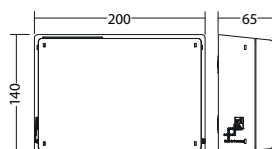

SN 2100 ECO LED 24V

Art. no. 810 231

Ceiling mounting

Protection category: IP65

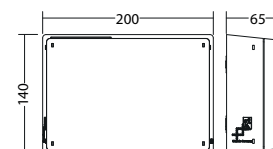

chain mounting adapter SN 2100

Art. no. 890 724

optional accessories

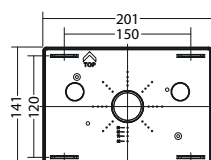



Universal LED downlight ideal for escape route illumination. UV resistant, heat filament tested polycarbonate housing with optional side cable entry and comfortable installation space.

Technical data

Material:	Polycarbonate
Illuminant:	LEDs
Luminous flux:	155 lm
Nominal voltage DC:	24 V ±20 %

Nominal current DC:	90 mA
Protection class:	III
Input terminals:	2.5mm ² feed through wiring
Temperature ta:	-15...+40 °C

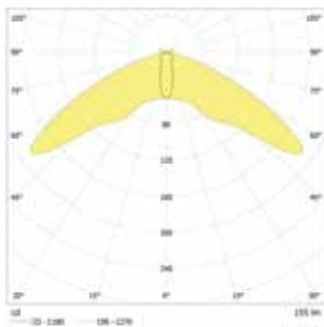

Minimum illumination 1.0 lx (middle of escape route), Maintenance factor 0.8

Beam diameter (m)	4.5m	10.7m	4.7m	1.5m
2.0	4.5	10.7	4.7	1.5
2.5	5.1	12.2	4.6	1.4
3.0	5.6	13.5	4.3	1.3
3.5	6.1	14.8	4.0	1.2
4.0	6.6	15.9	3.7	1.2
4.5	7.0	16.8	3.6	1.2
5.0	7.3	17.7	3.5	1.0
5.5	7.5	18.6	3.4	0.9

Articles

SN 2100 B-ECO LED 24V Art. no. 810 230

Ceiling mounting

Protection category: IP40

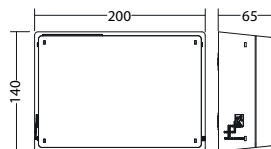

SN 2100 B-ECO LED 24V Art. no. 810 232

Ceiling mounting

Protection category: IP65

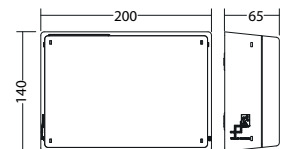

chain mounting adapter SN 2100 Art. no. 890 724

optional accessories

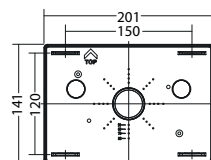







Dynamic emergency exit sign luminaires FL-Series

Dynamic emergency exit luminaires of the FL series can be used to indicate, block or change escape routes depending on a fire event.

Luminaires of the types FL 1530, FL 7188 and FL 808 are particularly suitable for combining dynamic and static luminaires, as they are also available as static emergency exit luminaires.

Instead of the static direction indicator, an arrow matrix indicates the safe route in the event of a fire, or closes off a smoke-filled area.

The FL range offers luminaires for almost every application – from robust stainless-steel luminaires with a high protection class to state-of-the-art, elegantly designed luminaires from the 'Straight Line' range.

	FL 1520	202
	FL 1530	204
	FL 7188 / 7288	206
	FL 808 / 828	210
	FL 6110	213





Dynamic double-sided straight-line emergency exit sign luminaire made of high quality, powder-coated aluminium. Ideal to display the safe escape route depending on the smoke situation inside a building. For single-sided use, the current consumption is reduced by 50%.

Technical data

Viewing distance:	20 m	Nominal current DC:	440 mA
Material:	Aluminium powder-coated	Protection class:	III
Illuminant:	LEDs	Input terminals:	2.5mm ² feed through wiring
Nominal voltage DC:	24 V ±25 %	Temperature ta:	-15...+40 °C

Available colours Add colour code to the article no. e.g. 800 014 LXX

RAL 9016 (Traffic white): L04 Special colour: L99

Articles

FL 1520 D / WA ILDD 24V

Art. no. 811 176

Wall or ceiling mounting

Protection category: IP40

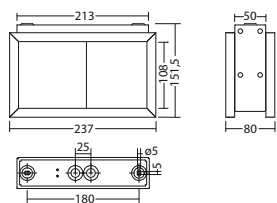

FL 1520 S ILDD 24V

Art. no. 811 178

Cable suspension mounting

Protection category: IP40

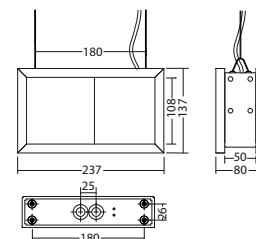



Dynamic single-sided Straight-Line emergency exit sign luminaire made of high quality, powder-coated aluminium. Ideal to display the safe escape route depending on the smoke situation inside a building.

Technical data

Viewing distance:	20 m	Nominal current DC:	220 mA
Material:	Aluminium powder-coated	Protection class:	III
Illuminant:	LEDs	Input terminals:	2.5mm ² feed through wiring
Nominal voltage DC:	24 V ±25 %	Temperature ta:	-15...+40 °C

Available colours Add colour code to the article no. e.g. 800 014 LXX

RAL 9016 (Traffic white): L04 Special colour: L99

Articles

FL 1520 PM ILDD 24V

Art. no. 811 177

Wall mounting

Protection category: IP40

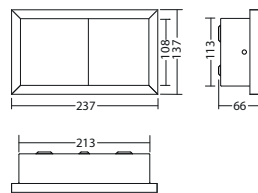

FL 1520 WE ILDD 24V

Art. no. 811 179

Recessed wall mounting

Protection category: IP40

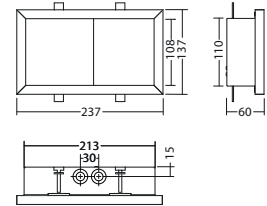



Dynamic double-sided straight-line emergency exit sign luminaire made of high quality, powder-coated aluminium. Ideal to display the safe escape route depending on the smoke situation inside a building. For single-sided use, the current consumption is reduced by 50%.

Technical data

Viewing distance:	30 m	Nominal current DC:	460 mA
Material:	Aluminium powder-coated	Protection class:	III
Illuminant:	LEDs	Input terminals:	2.5mm ² feed through wiring
Nominal voltage DC:	24 V ±25 %	Temperature ta:	-15...+40 °C

Available colours Add colour code to the article no. e.g. 800 014 LXX

RAL 9016 (Traffic white): L04 Special colour: L99

Articles

FL 1530 D / WA ILDD 24V

Art. no. 811 115

Wall or ceiling mounting

Protection category: IP40



FL 1530 P ILDD 24V

Art. no. 811 118

Pendulum mounting

Protection category: IP40





Dynamic single-sided Straight-Line emergency exit sign luminaire made of high quality, powder-coated aluminium. Ideal to display the safe escape route depending on the smoke situation inside a building.

Technical data

Viewing distance:	30 m	Nominal current DC:	230 mA
Material:	Aluminium powder-coated	Protection class:	III
Illuminant:	LEDs	Input terminals:	2.5mm ² feed through wiring
Nominal voltage DC:	24 V ±25 %	Temperature ta:	-15...+40 °C

Available colours Add colour code to the article no. e.g. 800 014 LXX

RAL 9016 (Traffic white): L04 Special colour: L99

Articles

FL 1530 PM ILDD 24V

Art. no. 811 117

Parallel wall mounting

Protection category: IP40



FL 1530 WE ILDD 24V

Art. no. 811 119

Recessed wall mounting

Protection category: IP40





Dynamic single-sided emergency exit sign luminaire made of high quality aluminium profile. Ideal to display the safe escape route depending on the smoke situation inside a building.

Technical data

Viewing distance:	35 m
Material:	Aluminium
Illuminant:	LEDs
Nominal voltage DC:	24 V ±20 %

Nominal current DC:	200 mA
Protection class:	III
Input terminals:	max. 2.5 mm ² single-core or max. 1.5mm ² multi-core with ferrule
Temperature ta:	-15...+40 °C

Articles

FL 7188 LED 24V Art. no. 800 100 V

Wall mounting

Protection category: IP40

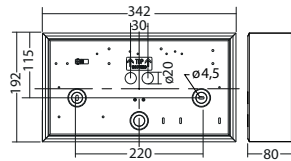



Dynamic double-sided emergency exit sign luminaire made of high quality aluminium profile. Ideal to display the safe escape route depending on the smoke situation inside a building.

For single-sided use, the current consumption is reduced by 50%.

Technical data

Viewing distance:	35 m
Material:	Aluminium
Illuminant:	LEDs
Nominal voltage DC:	24 V ±20 %

Nominal current DC:	400 mA
Protection class:	III
Input terminals:	max. 2.5 mm ² single-core or max. 1.5mm ² multi-core with ferrule
Temperature ta:	-15...+40 °C

Articles

FL 7288 D LED 24V Art. no. 800 102 V

Ceiling mounting

Protection category: IP40

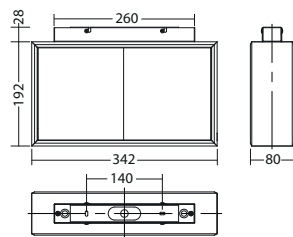

FL 7288 K LED 24V Art. no. 800 108 V

Chain mounting

Protection category: IP40

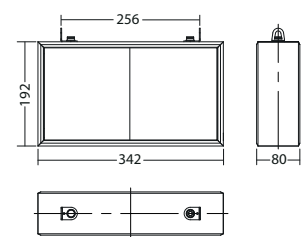

FL 7288 P LED 24V Art. no. 800 106 V

Pendulum mounting

Protection category: IP40

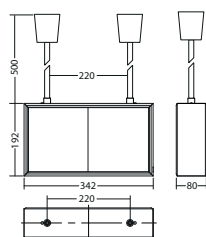

FL 7288 WA LED 24V Art. no. 800 104 V

Wall bracket mounting

Protection category: IP40

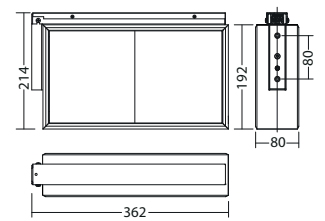







Dynamic single-sided emergency exit luminaire made of robust stainless steel with high protection category. Ideal to display the safe escape route depending on the smoke situation inside a building.

Technical data

Viewing distance:	30 m	Nominal current DC:	200 mA
Material:	Stainless steel	Protection class:	III
Illuminant:	LEDs	Input terminals:	max. 2.5 mm ² single-core or max. 1.5mm ² multi-core with ferrule
Nominal voltage DC:	24 V ±20 %	Temperature ta:	-15...+40 °C

Available colours Add colour code to the article no. e.g. 800 014 LXX

stainless steel: **L30** ■ RAL 7015 (Slate grey): **L16** ■ RAL 9016 (Traffic white): **L04** □ Special colour: **L99** 🌈

Articles

FL 808 LED 24V Art. no. 800 180 V

Wall mounting

Protection category: IP65

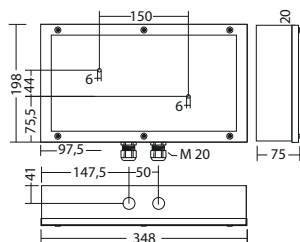



Dynamic double-sided emergency exit luminaire made of robust stainless steel with high protection category. Ideal to display the safe escape route depending on the smoke situation inside a building. For single-sided use, the current consumption is reduced by 50%.

Technical data

Viewing distance:	30 m
Material:	Stainless steel
Illuminant:	LEDs
Nominal voltage DC:	24 V ±20 %

Nominal current DC:	400 mA
Protection class:	III
Input terminals:	max. 2.5 mm ² single-core or max. 1.5mm ² multi-core with ferrule
Temperature ta:	-15...+40 °C

Available colours Add colour code to the article no. e.g. 800 014 LXX

stainless steel: **L30** ■ RAL 7015 (Slate grey): **L16** ■ RAL 9016 (Traffic white): **L04** □ Special colour: **L99** 🌈

Articles

FL 828 K LED 24V Art. no. 800 182 V

Chain mounting

Protection category: IP65

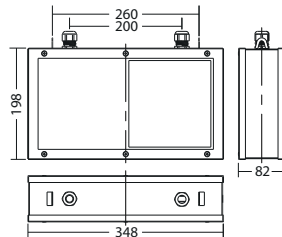

FL 828 WA LED 24V Art. no. 800 184 V

Wall bracket mounting

Protection category: IP65

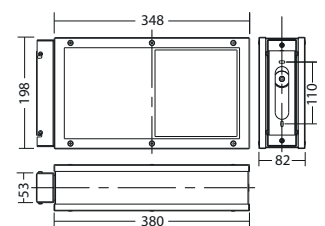





Low level recessed wall installation luminaire for dynamic indication of the safe escape route depending on the smoke spreading during a fire. Luminaire with powder-coated metal cover for installation in double wall box for concrete, cavity wall or in-wall.

Technical data

Material:	Sheet steel powder-coated	Protection class:	III
Illuminant:	LEDs	Input terminals:	2.5mm ² feed through wiring
Nominal voltage DC:	24 V ±25 %	Temperature ta:	-15...+40 °C
Nominal current DC:	115 mA		

Available colours Add colour code to the article no. e.g. 800 014 **LXX**

RAL 9016 (Traffic white): **L04** Special colour: **L99**

Articles

FL 6110 ILDD 24V

Art. no. 811 161

Recessed wall mounting

Protection category: IP40

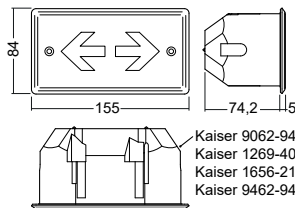



EX-luminaire

Emergency exit sign and safety luminaire

The Ex luminaire series offers emergency exit sign and safety luminaires in 24V technology for hazardous areas in zones 1, 2, 21 and 22. The luminaires can be used as safety luminaires for wall and ceiling mounting and with pictogram as escape sign luminaires for wall mounting.

Advantages

- 24V technology
- Versatile mounting possibilities

Applications

- Explosion-hazardous zones 1, 2, 21 and 22
- Laboratory facilities
- Painting booths
- Chemical industry



EX 7000

215







Safety- / Exit luminaire for EX-Zone 1, 21, 2, 22 according to ATEX-classification Group II category 2 G D. Luminaire for ceiling / wall mounting, made of high-quality die-cast aluminium.

Technical data

Viewing distance:	30 m	Nominal current DC:	200 mA
Material:	Die-cast aluminum	Protection class:	III
Illuminant:	LEDs	Input terminals:	2.5mm ² feed through wiring
Nominal voltage DC:	24 V ±20 %	Temperature ta:	-20...+55 °C

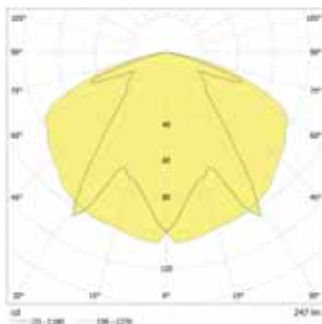

Minimum illumination 1.0 lx (middle of escape route), Maintenance factor 0.8

Distance (m)	2.5	4.7	11.6	7.4	2.9
2.5	4.7	12.6	8.0	2.9	
4.0	4.9	13.7	8.3	3.2	
5.0	4.9	14.0	8.8	3.6	
6.0	4.7	14.2	9.7	3.9	
7.0	4.2	14.0	10.0	2.3	
8.0	3.3	13.6	-	-	

Minimum illumination 1.0 Lux (area illumination), Maintenance factor 0.8

Distance (m)	2.5	2.3	5.9	7.2	2.5
3.0	2.5	6.5	7.8	2.5	
4.0	3.0	7.2	8.5	3.0	
5.0	3.2	8.1	9.4	3.3	
6.0	3.3	9.0	10.5	3.3	
7.0	3.3	8.0	11.2	2.3	
8.0	2.0	7.0	11.2	2.0	

Articles

EX 7000 LED 24V

Art. no. 810 176

Wall or ceiling mounting

Protection category: IP66



Your key contact for emergency lighting!

Since its foundation in 1995 INOTEC Sicherheitstechnik GmbH has grown into a medium-sized company with more than 250 employees. We became a firm partner for a lot of planner and installer in the field of emergency and safety lighting. This means for us that you can count with our expertise at any time during your project.

Planning

In addition to the R&D of our products, we also rely on Germany as a business location for production. Therefore we work together with high qualified German suppliers. The final assembly is done at our headquarters in Ense, Germany. Because of the wide product range a sophisticated logistics is needed to guarantee short delivery times.



Our nationwide distribution team supports you early within the country and abroad with the project planning and the selecting of a suitable emergency lighting system.

To offer you shorter ways and more availability for technical and business questions we have four distribution centres in Pinneberg, Potsdam, Nördlingen and Ense.



R&D

Safety is the most important quality feature of our products. For this reason they are developed and tested by own INOTEC employees / quality assurance. Thereby, we cover the complete process of construction, hardware and software development. Having this competence and knowledge in house, we can advise you in the best way. If necessary products can be adapted to your project requirements.

Production / Logistics



The art of being local

INOTEC Sicherheitstechnik GmbH is represented in many countries of Europe and the Middle East by agencies and strategic partners for sales and service purposes. Working closely with our export department in our parent company in Germany, we develop together the required know-how to fulfill all practical and theoretical requirements of emergency lighting applications. Thus, we ensure commercial and technical support for emergency lighting applications on the spot by taking local standards into account.

Your benefits:

- + Contact person in your region
- + Consideration of local standards
- + On-site training in practical and theoretical subject

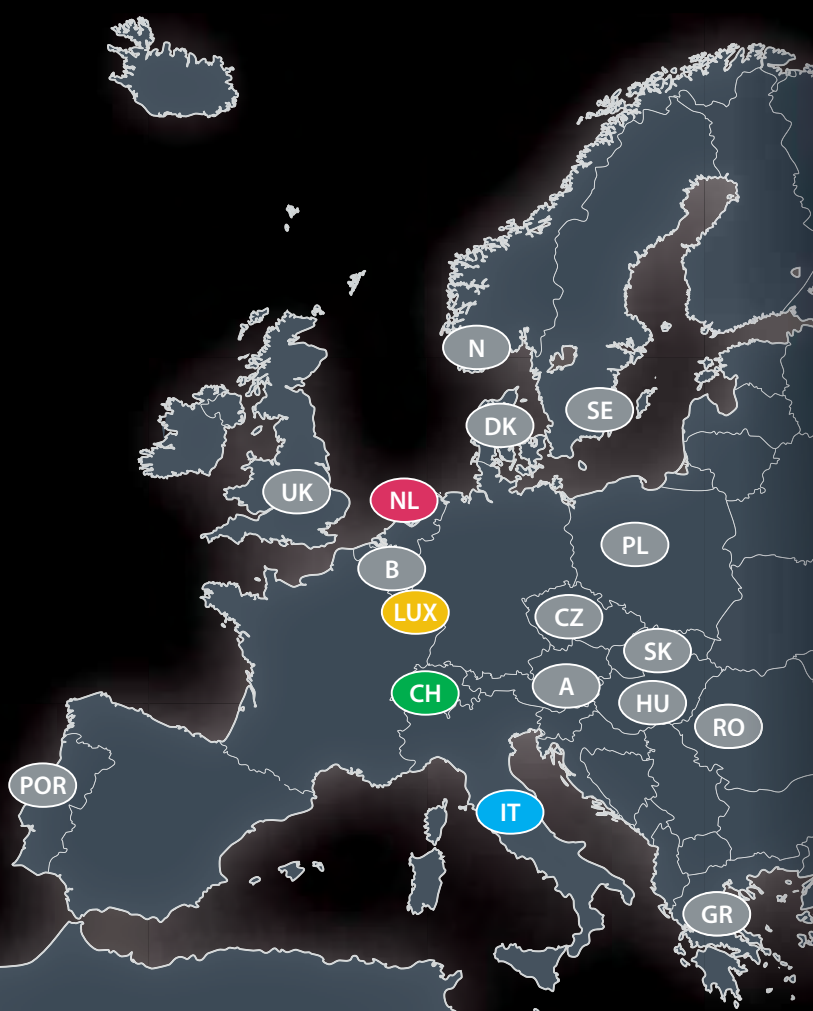

INOTEC Sicherheitstechnik (Schweiz) AG

✉ Industriepark 5
CH-8610 Uster
☎ info@inotec-licht.ch
☎ +41 43 366 4400

INOTEC Licht S.R.L.

✉ Via Nuova Circonvallazione 69
I - 47924 Rimini
☎ ufficio.tecnico@inotec-licht.it
☎ +39 541 7919 11

Lux-INOTEC Sicherheitssysteme S.A

✉ Zone Industrielle Rolach, Hall 4
L - 5280 Sandweiler
☎ info@inotec.lu
☎ +352 26 66 55 88

INOTEC Noodverlichting BV

✉ Koningslijn 14
NL-7312 GH Apeldoorn
☎ info@inotec-noodverlichting.nl
☎ + 31 55 355 1201

Inotec Middle East FZC

✉ P.O. Box 9338
SAIF Zone, Sharjah
U.A.E
☎ info@inotecmena.com
☎ +971 4 3277 605



Find your local contact person!

www.inotec-licht.de/kontakt/internationale-partner

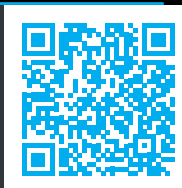

On spot for you

Your sales representative, responsible for your area is your contact person and gets supported by the technical and commercial internal sales in the local office. As a team, they take care of your concerns regarding safety lighting and support your project design.

Training facilities are available in every sales centre to encourage the dialogue between INOTEC and the customers. Beside theoretical topics like emergency lighting standards, practical knowledge on INOTEC products is presented in a comprehensible and up-to-date manner.

- + Your benefits: Personal, local contact person
- + Focus on your regional requirements and expectations
- + Product training and knowledge transfer in your regional sales centre



Find your local contact person!

www.inotec-licht.de/kontakt/ansprechpartner/



Sales centre North

- ✉ Osterholder Allee 2
25421 Pinneberg
- 🌐 buero-nord@inotec-licht.de
- ☎ +49 4101 58 78 -10

Sales centre East

- ✉ Am Buchhorst 34
14478 Potsdam
- 🌐 buero-ost@inotec-licht.de
- ☎ +49 331 87 00 0 -646

Sales centre South

- ✉ Schäufelinstraße 14
86720 Nördlingen
- 🌐 buero-sued@inotec-licht.de
- ☎ +49 9081 80 57 9 -10

Sales centre West

- ✉ Am Buschgarten 17
59469 Ense
- 🌐 buero-west@inotec-licht.de
- ☎ +49 2938 97 30 -775

Service is the key



For us as the manufacturer an all-inclusive "After-Sales-Service" for our customer is very important. Our free technical hotline is available in Germany for any kind of technical questions concerning our products. Our own service technicians are ready for basic programming, extending, inspections and repairing. To offer the best support to our clients, we only work with our own technicians and do not refer to any subcontractors. Outside of Germany we have employees trained by INOTEC, who offer the best service.

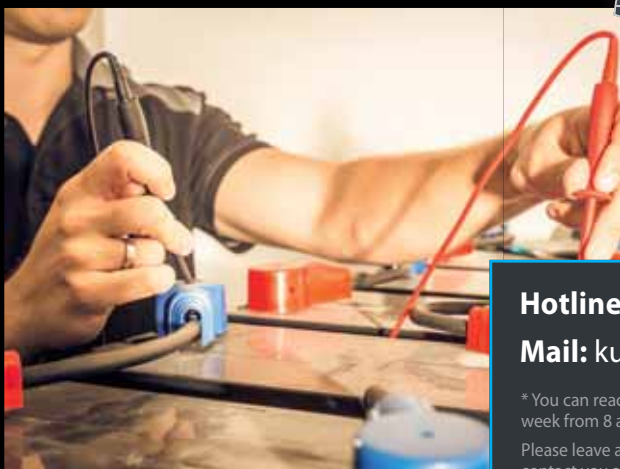

Hotline: +49 2938-9730-777 *

Mail: kundendienst@inotec-licht.de

* You can reach our hotline within the business hours during the week from 8 am till 4.30 pm.

Please leave a message outside of our business hours, so we can contact you as soon as possible.



Luminaire categories

High protection category >IP54

Type	Category	Page
SN 6114	step luminaire	120
SN 6204.2	wall luminaire	127
SN 6206-11	wall luminaire	133
SN 8040	downlight	173
SN 8106-11	downlight	175
SN 8500	downlight	171
SN 804	stainless steel luminaire	143
SNP 808 / SNP 828	stainless steel luminaire	138
FL 808 / FL 828	stainless steel luminaire	210
SN 2100	polycarbonate luminaire	193
SNP 2130 / SNP 2230	polycarbonate luminaire	191

Low-power 24V luminaires Ideal for use with CLS 7Ah

Type	Category	Page
SN 6206-11	wall luminaire	133
SN 8106-11	downlight	175
SN 9424-03 ALB	downlight	157
SN 8424-03 ALB	downlight	163
SN 9024	downlight	149
SNP 1520	straight-Line	79
SNP 1214 / 1216	edge light	92

D.E.R.

Dynamic Escape Routing

Deeper information about the D.E.R. system and luminaires can be found in the specific D.E.R. catalogue.

Dynamic exit sign luminaires

With the dynamic emergency exit luminaires from the FL-range, escape routes can be signposted, blocked or changed, depending on the fire event.

The luminaire types FL 1530, FL 7188 and FL 808 are suitable especially for a mixture use of dynamic and static exit sign luminaires in a building, as these luminaire types are also available in a static version. Instead of the standard exit sign, a LED matrix shows the safe way in case of emergency and blocks the smoky areas.

Type	Category	Page
FL 1530	straight-line	204
FL 7188 / 7288	aluminium profile luminaire	206
FL 808 / FL 828	stainless steel luminaire	210



INOTEC Sicherheitstechnik GmbH
Am Buschgarten 17
D - 59469 Ense

Tel +49 2938 97 30 -0

Fax +49 2938 97 30 -29

info@inotec-licht.de

www.inotec-licht.de

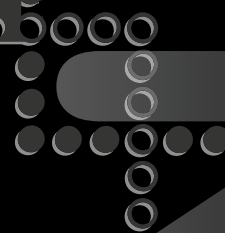

INOTEC
Sicherheitstechnik GmbH